

ARTICLE CATALOGUE 2012/13

ORTNER
KACHELOFEN MIT SYSTEM



ORTNER GMBH



ORTNER INSIDE

ORTNER
KACHELOFEN MIT SYSTEM

Hürmer Straße 36
A-3382 Loosdorf/Melk

T +43 (0) 2754 / 2707
F +43 (0) 2754 / 2708
E vertrieb@ortner-cc.at

www.ortner-cc.at
www.ortnerinside.at

Changes and errors excluded.



www.ortner-cc.at

ORTNER GMBH SALES DEPARTMENT



Martin Hübner
Head of sales department
huebner@ortner-cc.at
+43 (0) 2754 / 2707 58



Maximilian Deichholz
Sales Northern Germany
deichholz@ortner-cc.at
+49 172 / 32 08 392



Tobias Kleinrubatscher
Sales West Austria
kleinrubatscher@ortner-cc.at
+43 664 / 82 72 620



Katrin Lerchecker
Sales office
lerchecker@ortner-cc.at
+43 (0) 2754 / 2707 37

ORTNER GMBH TRAINING TEAM



Heinz Hirtenlehner
Product training and
practice
hirtenlehner@ortner-cc.at
+43 664 / 82 72 598



Stefan Hübner
Product training
stefan@ortner-cc.at



Martina Nenning
Coordination training
office@ortner-cc.at
+43 (0) 2754 / 2707

ORTNER GMBH R&D



Dipl.-Ing. Martin Brader
Head of R&D
brader@ortner-cc.at
+43 (0) 2754 / 2707-40

The Team of the ORTNER GmbH provides you as contact person for each technical and product-specific requests!

INDEX OF CONTENTS

MORTARS, ADHESIVES AND PLASTERS

Shell materials	Page 4
Construction materials	Page 5
Special mortars	Page 5
Stove plasters	Page 6
Fresco	Page 7
Reinforcements	Page 8
Putties for tiled stoves	Page 9
Paints for heated surfaces	Page 10
Elastic putty and silicone; Elastic putty and silicone	Page 11 - 12

READY STOVE-SETTING MATERIALS

Cast fireclay boards	Page 13 - 15
Stove boards	Page 16
Accumulation boards; Special construction elements; Special fireclay elements	Page 17
Universal boards, elbows and radii	Page 18

ORTNER COMBUSTION CHAMBERS AND SET

Combustion chamber GOR44	Page 24 - 27
Combustion chamber GO8T	Page 28 - 29
Combustion chamber GO8	Page 30 - 31
Combustion chamber GO15	Page 32 - 33
Combustion chamber versions	Page 34 - 35
ORTNER stoves sets	Page 36 - 37
ORTNER kitchen stove	Page 38

MOUNTABLE CERAMIC MODULES, KMS, CHIMNEY CONNECTING ELEMENTS, BIS,

Mountable ceramic modules	Page 39
Ceramic accumulation module KMS 300 + BIS	Page 40 - 41
Ceramic accumulation module KMS 240 + BIS	Page 42 - 43
Chimney connections	Page 44

INSULATING MATERIALS

Isoboard, Isoboard HD	Page 45
-----------------------	---------

PROCESSING

Supplies	Page 46
----------	---------

PIPES

Smoke pipes	Page 47 - 48
Flexible aluminum pipes, heat-resistant pipes	Page 49

THE ORTNER SPECIAL ARTICLES

Chimney caps	Page 50
Special accessories	Page 50
Tools	Page 51 - 52

PRICE LIST

Price list	Page 53 - 97
------------	--------------

NOTES

Index	Page 100 - 101
-------	----------------

MORTARS, ADHESIVES AND PLASTERS



SHELL MATERIALS

ADHESIVE MORTAR

The ORTNER adhesive mortar "Das Original" 0 – 2 mm is a hydraulically-setting, grey mortar, meant for ceramic and fireclay products. For use in areas exposed to the temperatures up to 1000 °C.

ARTICLE	ARTICLE NR.	SPECIFICATION	AMOUNT
Adhesive mortar	OR110-20	Graining 0 – 2 mm	1 sack = 20 kg, 1 palette = 48 sacks

* Reduction liquid for adhesive mortar "Das Original" and adhesive mortar "Crème" see page 12



ADHESIVE MORTAR "CRÈME"

The ORTNER adhesive mortar "Crème" 0 – 1,2 mm has the same features and application as the ORTNER adhesive mortar "Das Original". Additionally this white mass can be used as mortar and putty. For use in areas exposed to the temperatures up to 1000 °C.

ARTICLE	ARTICLE NR.	SPECIFICATION	AMOUNT
Adhesive mortar Crème	OR110CR	Graining 0 – 1,2 mm	1 sack = 20 kg, 1 palette = 48 sacks

* Reduction liquid for adhesive mortar "Das Original" and adhesive mortar "Crème" see page 12



PRESSURE-SENSITIVE ADHESIVE

The ORTNER pressure-sensitive adhesive is a universal adhesive mortar for tiled stove and chimney constructions, for constructions, smoothing and spackling. Ideal for the shells in lightweight construction. For use in areas exposed to the temperatures up to 600 °C.

ARTICLE	ARTICLE NR.	SPECIFICATION	AMOUNT
Pressure-sensitive adhesive	OR115	Graining 0 – 1,2 mm	1 sack = 20 kg, 1 palette = 48



CONSTRUCTION MATERIALS

MORTAR

Mortar is a ceramically-setting, ready to use mortar to be used with construction materials in traditional tiled and accumulation stoves construction. **For use in areas exposed to the temperatures up to 1200 °C.**

ARTICLE	ARTICLE NR.	SPECIFICATION	AMOUNT
Mortar	OR130-20	Fine graining (beige)	1 sack = 20 kg, 1 palette = 48 sacks



HK MORTAR

The **ORTNER HK mortar 0 – 1,2 mm** is a hydraulically setting and ceramically-setting mortar, for fixing the fireclay elements in areas **exposed to the temperatures up to 1200 °C.**

ARTICLE	ARTICLE NR.	SPECIFICATION	AMOUNT
HK mortar	OR160	Graining 0 – 1,2 mm,	1 sack = 20 kg, 1 palette = 48 sacks

TIP



SPECIAL MORTARS

CAST FIRECLAY MASS

Fireclay mass for individual casting of bearing and non-bearing elements, construction bases inside the firing chambers as well as elements for constructing walls and the shell in the warmth conducting areas **exposed to the temperatures up to 450 °C.**

ARTICLE	ARTICLE NR.	SPECIFICATION	AMOUNT
Cast fireclay mass	OR120	Graining 0 – 5 mm	1 sack = 25 kg, 1 palette = 42 sacks



NEW REFRACTORY MORTAR

The **ORTNER refractory mortar** is a powdered, chemically-setting repair mortar. The mortar is suited for quick corrections as well as permanent reparations of the defect firebox areas exposed to the max. temperature of up to 1.200 °C. The **ORTNER refractory mortar** is to be mixed with the addition of water.

ARTICLE	ARTICLE NR.	SPECIFICATION	AMOUNT
Refractory mortar	OR9934	Repair mortar; powder	1 can = 1 kg; 1 carton = 6 cans



REPAIR MORTAR / PHOSPHATE BONDED

For special uses within problem zones expose to high temperatures. The mortar is made up of 2 ingredients (mortar and phosphate). The ingredients create a fast setting repair mass that requires no drying. The combustion chamber can be used 2 hours after the application of the repair mortar. For areas **exposed to the permanent temperatures up to 1700 °C.**

ARTICLE	ARTICLE NR.	SPECIFICATION	AMOUNT
Repair mortar	OR9932-25	Graining medium = 0 – 4 mm	1 bucket = 2,5 kg + 1 bottle = 0,6 l
Repair mortar	OR9932	Graining medium = 0 – 4 mm	1 bucket = 5 kg + 1 bottle = 1,2 l

STORE FROST PROTECTED!



NEW REFRACTORY CONCRETE 2200

The refractory concrete is suited for producing firebox parts exposed to the max. temperatures of up to 1.200 °C.

ARTICLE	ARTICLE NR.	SPECIFICATION	AMOUNT
FB 2200	OR-FB2200	pulverulent	bucket = 20 kg



STOVE PLASTERS

FREE-STYLE STRUCTURAL PLASTER

The **ORTNER** free-style structural plaster is a white thin film plaster of extraordinary adhesiveness for creating thin and thick layers. To be used in thin film technique as well for forming ledges and structures of max. 50 mm. For areas exposed to the temperatures up to 200 °C.

ARTICLE	ARTICLE NR.	SPECIFICATION	AMOUNT
Free-style structural plaster	OR151	Graining 0 – 0,5 mm	1 sack = 20 kg; 1 palette = 48 sacks
Free-style structural plaster	OR150-20	Graining 0 – 1 mm	1 sack = 20 kg; 1 palette = 48 sacks



STOVE PLASTER

The extraordinary adhesive white thin-film is available in graining 0 – 0,5 mm and 0 – 1 mm. The **ORTNER** stove plaster enables free formation of the outer heating surface. For use in areas exposed to the temperatures up to 200 °C.

ARTICLE	ARTICLE NR.	SPECIFICATION	AMOUNT
Stove plaster	OR10-05-20	Graining 0 – 0,5 mm	1 sack = 20 kg; 1 palette = 48 sacks
Stove plaster	OR101-20	Graining 0 – 1 mm	1 sack = 20 kg; 1 palette = 48 sacks



ADHESIVE MORTAR "CREME"

The **ORTNER** adhesive mortar "Creme" 0 – 1,2 mm has the same features and application as the **ORTNER** adhesive mortar "Das Original". Additionally this white mass can be used as mortar and putty. For use in areas exposed to the temperatures up to 1000 °C.

ARTICLE	ARTICLE NR.	SPECIFICATION	AMOUNT
Adhesive mortar "Creme"	OR110CR	Graining 0 – 1,2 mm	1 sack = 20 kg; 1 palette = 48 sacks

* Reduction liquid for adhesive mortar "Das Original" and adhesive mortar "Crème" see page 12



BOND AND KEY COAT

The **ORTNER** bond and key coat is a pure white thin-film plaster to be used for the heated surfaces in areas exposed to the temperatures up to 150 °C. Maximal layer thickness is 4 mm.

ARTICLE	ARTICLE NR.	SPECIFICATION	AMOUNT
Bond and key coat	OR15	Graining 0 – 0,5 mm	1 sack = 20 kg; 1 palette = 48 sacks



ADHESIVE PLASTER

The **ORTNER** adhesive plaster is a hydraulically Winding plaster of the undetectable graining, that has been created especially for the Leeds of the modern oven-setters. For use in areas exposed to the temperatures up to 200 °C.

ARTICLE	ARTICLE NR.	SPECIFICATION	AMOUNT
Adhesive plaster	OR100	Finest graining	1 sack = 25 kg; 1 palette = 42 sacks

FRESCO-SURFACE

FINE-GRAINED MORTAR

The **ORTNER** fine-grained mortar is a thin-film fine grained mortar for creating very smooth layers. For use in areas **exposed to the temperatures up to 150 °C**.

ARTICLE	ARTICLE NR.	SPECIFICATION	AMOUNT
Fine-grained mortar	OR100-0110	Graining 0 – 0,02 mm	1 sack = 10 kg, 1 palette = 80 sacks



FRESCO

Spackling paste **FRESCO** is a mortar for the outer surface of tiled stoves, chimneys and plastered walls, available in a variety of colors. Should the desired color not be in our assortment, it is possible to mix different colors with each other. Always use the mixing liquid! For use in areas **exposed to the temperatures up to 150 °C**.

ARTICLE	ARTICLE NR.	SPECIFICATION	AMOUNT
Spackling paste FRESCO	OR100-015	White	1 bucket = 2 kg
Spackling paste FRESCO	OR100-02	Black	1 bucket = 2 kg
NEW Spackling paste FRESCO	OR100-03	Slate brown	1 bucket = 2 kg
Spackling paste FRESCO	OR100-04	Eggshell	1 bucket = 2 kg
Spackling paste FRESCO	OR100-05	Ivory	1 bucket = 2 kg
Spackling paste FRESCO	OR100-06	Inca gold (yellow 1)	1 bucket = 2 kg
Spackling paste FRESCO	OR100-07	Titanic (green 3)	1 bucket = 2 kg
Spackling paste FRESCO	OR100-08	Antique pink (red 2)	1 bucket = 2 kg
Spackling paste FRESCO	OR100-10	Lavender (blue 2)	1 bucket = 2 kg
NEW Spackling paste FRESCO	OR100-11	Dark Brown	1 bucket = 2 kg
Spackling paste FRESCO	OR100-12	Shell (orange 1)	1 bucket = 2 kg
Spackling paste FRESCO	OR100-13	Sienna (red 1)	1 bucket = 2 kg
Spackling paste FRESCO	OR100-14	Green 8	1 bucket = 2 kg
Spackling paste FRESCO	OR100-15	Blue 4	1 bucket = 2 kg
Spackling paste FRESCO	OR100-17	Red 4	1 bucket = 2 kg
Spackling paste FRESCO	OR100-18	Yellow 2	1 bucket = 2 kg
Spackling paste FRESCO	OR100-19	Orange 2	1 bucket = 2 kg
Spackling paste FRESCO	OR100-20	Blue 1	1 bucket = 2 kg
Spackling paste FRESCO	OR100-21	Green 1	1 bucket = 2 kg
Spackling paste FRESCO	OR100-22	Green 6	1 bucket = 2 kg
Spackling paste FRESCO	OR100-23	Violet 1	1 bucket = 2 kg
Spackling paste FRESCO	OR100-24	Anthracite	1 bucket = 2 kg
Spackling paste FRESCO	OR100-25	Slate grey	1 bucket = 2 kg
Spackling paste FRESCO	OR100-26	Concrete Grey	1 bucket = 2 kg
NEW Fresco Design basic kit	OR-SA002000	Consists of: 2 bags of smoothing plaster; 1 unit of reducing agent (5L); Fresco: white, black slate brown, slate grey, sienna and shell (a bucket each)	2 bags, 1 canister 6 buckets a 2 kg



MIXING LIQUID

Reduces the abrasibility of the **ORTNER** seams, Fresco and paints.

ARTICLE	ARTICLE NR.	SPECIFICATION	AMOUNT
Mixing liquid	OR900-5	1 canister	5 liters
Mixing liquid	OR900	1 canister	10 liters



STORE FROST PROTECTED!

* = special color, available only on order.

** = **ORTNER** pouring aid; page 50

REINFORCEMENTS

The ORTNER reinforcements are temperature resistant, extensive layer for absorption of stretching trains, which despite multiple layering and proper bracing, might affect even the stove's surface.

FIBERGLASS GRID

... for the shell together with free-style structural plaster, adhesive mortar "Creme", bond and key coat, stove mortar and spackling paste Fresco.

ARTICLE	ARTICLE NR.	SPECIFICATION	AMOUNT
Glass fiber grid	OR972	6 x 6 mm, tight, trick	1 reel = 50 m2; 5,5 kg



FIBERGLASS SILK

Optional for shells together with finishing plaster.

ARTICLE	ARTICLE NR.	SPECIFICATION	AMOUNT
Fibreglass silk grid	OR973	very tight	1 reel = 20 m2; 1,5 kg



TEXTILE WALLPAPER

Adhesive plaster on textile wallpaper.

ARTICLE	ARTICLE NR.	SPECIFICATION	AMOUNT
Textile wallpaper	OR960	thick	1 reel = 50 m2; 6 kg

PUTTIES FOR TILED STOVES

PUTTIES FOR TILED STOVE

Mass of extended adhesion and exceptional fiber reinforcements, developer especially for the tiled stoves. In the ORTNER assortment there are the paints of the colors of the putties. Exposed to the temperatures up to 150 °C. Colors marked with the letter „A“ must be tempered exclusively by means of the reducing agent.



ARTICLE	ARTICLE NR. 1 BUCKET = 2 KG	ARTICLE NR. 1 BUCKET = 4,5 KG	SPECIFICATION	
Putty	OR5000-2	OR5000-4	000 Black	„A“
Putty	OR5097-2	OR5097-4	097 Red black / Basalt	„A“
Putty	OR5098-2	OR5098-4	098 Blue black	„A“
Putty	OR5100-2	OR5100-4	100 White	
Putty	OR5220-2	OR5220-4	220 White grey	
Putty	OR5240-2	OR5240-4	240 Bright grey	
NEW Putty	OR5250-2	OR5250-4	250 Slate grey	„A“
Putty	OR5260-2	OR5260-4	260 Dark grey	„A“
NEW Putty	OR5270-2	OR5270-4	270 Cement grey	„A“
Putty	OR5280-2	OR5280-4	280 Anthracite	„A“
Putty	OR5320-2	OR5320-4	320 Egg-white / Birch	
Putty	OR5340-2	OR5340-4	340 Hazelnut	„A“
Putty	OR5360-2	OR5360-4	360 Dark brown	„A“
Putty	OR5380-2	OR5380-4	380 Dark ochre	„A“
Putty	OR5420-2	OR5420-4	420 Light blue *	
Putty	OR5440-2	OR5440-4	440 Blue	„A“
Putty	OR5460-2	OR5460-4	460 Dark blue	„A“
Putty	OR5490-2	OR5490-4	490 Rustic blue	„A“
Putty	OR5560-2	OR5560-4	560 Dark turquoise	
Putty	OR5620-2	OR5620-4	620 Light green	
Putty	OR5630-2	OR5630-4	630 Capri blue	
Putty	OR5640-2	OR5640-4	640 Moos green	„A“
Putty	OR5660-2	OR5660-4	660 Dark green	„A“
Putty	OR5680-2	OR5680-4	680 Ivy green	„A“
Putty	OR5690-2	OR5690-4	690 Rustic green	„A“
Putty	OR5720-2	OR5720-4	720 Light rusty	„A“
Putty	OR5740-2	OR5740-4	740 Rusty	„A“
Putty	OR5760-2	OR5760-4	760 Dark rusty	„A“
Putty	OR5790-2	OR5790-4	790 Red brow	„A“
Putty	OR5850-2	OR5850-4	850 Salmon	
Putty	OR5910-2	OR5910-4	910 Ivory	
Putty	OR5920-2	OR5920-4	920 Mohair (White beige)	
Putty	OR5940-2	OR5940-4	940 Light raspberry*	
Putty	OR5960-2	OR5960-4	960 Dark raspberry*	„A“
Putty	OR5980-2	OR5980-4	980 Dark red	„A“

MIXING LIQUID

Reduces the abrasibility of the ORTNER seams, Fresco and paints.

ARTICLE	ARTICLE NR.	SPECIFICATION	AMOUNT
Mixing liquid	OR900-5	1 canister	5 liters
Mixing liquid	OR900	1 canister	10 liters



Be careful when pointing ceramic elements with decorative cracks (eg. Craquelé)! Putty that gets into the miniature cracks in the glaze causes irreparable staining. You need therefore to choose the putty color fitting the glaze color.



STORE FROST PROTECTED!

* = special color, available only on order.

** = ORTNER pouring aid; page 50

PAINTS FOR HEATED SURFACES

PAINTS

For plastered, warmth conducting surfaces. The ORTNER paints stand out due to their ability to cover scuffs. For use in areas exposed to the temperatures up to 150 °C. Two paint layers are necessary. Colors marked with the letter „A“ must be tempered exclusively by means of the reducing agent.



NEW

NEW

ARTICLE	ARTICLE NR.	SPECIFICATION		AMOUNT
Paint	OR6000	000 Black *	„A“	1 bucket = 2kg
Paint	OR6097	097 Red black / Basalt*	„A“	1 bucket = 2kg
Paint	OR6098	098 Blue black*	„A“	1 bucket = 2kg
Paint	OR6100	100 White		1 bucket = 2kg
Paint	OR6220	220 White grey		1 bucket = 2kg
Paint	OR6240	240 Light grey		1 bucket = 2kg
Paint	OR6250	250 Slate grey	„A“	1 bucket = 2kg
Paint	OR6260	260 Dark grey	„A“	1 bucket = 2kg
Paint	OR6270	270 Cement grey	„A“	1 bucket = 2kg
Paint	OR6280	280 Anthracite	„A“	1 bucket = 2kg
Paint	OR6320	320 Egg-white / Birch *		1 bucket = 2kg
Paint	OR6340	340 Hazelnut	„A“	1 bucket = 2kg
Paint	OR6360	360 Dark brown*	„A“	1 bucket = 2kg
Paint	OR6380	380 Dark ochre*	„A“	1 bucket = 2kg
Paint	OR6420	420 Light blue		1 bucket = 2kg
Paint	OR6440	440 Blue*	„A“	1 bucket = 2kg
Paint	OR6460	460 Dark blue*	„A“	1 bucket = 2kg
Paint	OR6490	490 Rustic blue	„A“	1 bucket = 2kg
Paint	OR6560	560 Dark turquoise *		1 bucket = 2kg
Paint	OR6620	620 Light green		1 bucket = 2kg
Paint	OR6630	630 Capri blue*		1 bucket = 2kg
Paint	OR6640	640 Moos green*	„A“	1 bucket = 2kg
Paint	OR6660	660 Dark green	„A“	1 bucket = 2kg
Paint	OR6680	680 Ivy green*	„A“	1 bucket = 2kg
Paint	OR6690	690 Rustic green*	„A“	1 bucket = 2kg
Paint	OR6720	720 Light rusty	„A“	1 bucket = 2kg
Paint	OR6740	740 Rusty	„A“	1 bucket = 2kg
Paint	OR6760	760 Dark rusty	„A“	1 bucket = 2kg
Paint	OR6790	790 Brown red*	„A“	1 bucket = 2kg
Paint	OR6850	850 Salmon		1 bucket = 2kg
Paint	OR6910	910 Ivory		1 bucket = 2kg
Paint	OR6920	920 Mohair (White beige)		1 bucket = 2kg
Paint	OR6940	940 Light raspberry*		1 bucket = 2kg
Paint	OR6960	960 Dark raspberry*	„A“	1 bucket = 2kg
Paint	OR6980	980 Dark red	„A“	1 bucket = 2kg

MIXING LIQUID

Reduces the abrasibility of the ORTNER seams, Fresco and paints.

ARTICLE	ARTICLE NR.	SPECIFICATION	AMOUNT
Mixing liquid	OR900-5	1 canister	5 liters
Mixing liquid	OR900	1 canister	10 liters



**

STORE FROST PROTECTED!

ELASTIC PUTTY AND SILICONE

ELASTIC PUTTY

Elastic putty is ready to use, plastic mass made of ceramic fibers. It hardens under the influence of temperature. It is especially good for sealing with a layer of max. 30 mm. **The maximal temperature is indicated on the package.**

ARTICLE	ARTICLE NR.	SPECIFICATION	AMOUNT
(A) Elastic putty	OR9907-03	White	small can = 0,3 kg
(B) Elastic putty	OR9907-10	White	medium can = 1,0 kg
(C) Elastic putty	OR9907-20	White	bucket = 2,0 kg
(D) Elastic putty	OR9907-K	White	cartridge = 0,40 kg
(A) Elastic putty	OR9910-03	Black	small can = 0,3 kg
(B) Elastic putty	OR9910-10	Black	medium can = 1,0 kg
(C) Elastic putty	OR9910-20	Black	bucket = 2,0 kg
(D) Elastic putty	OR9910-K	Black	cartridge = 0,40 kg



STORE FROST PROTECTED!

HEAT-RESISTANT SILICONE

Special silicone for heat-resistant sealing and gluing. **Remains plastic.**

ARTICLE	ARTICLE NR.	SPECIFICATION	AMOUNT
Silicone	OR9926	White, up to 250 °C	cartridge = 0,5 kg
Silicone	OR9928	Gray, up to 250 °C	cartridge = 0,5 kg
Silicone	OR9925	Black, up to 250 °C	cartridge = 0,5 kg
Silicone	OR9927	Red, up to 250 °C	cartridge = 0,5 kg



STORE FROST PROTECTED!

HEAT-RESISTANT GLUES

ORFIX 10 – ACID-RESISTANT

This adhesive mortar is chemically-setting and acid-resistant. For use in areas permanently exposed to the temperatures up to 1000 °C. Due to its features it is perfect for joining individual KMS modules and sealing the crevices between them. Orfix 10 is available in black and in the fireclay color.

ARTICLE	ARTICLE NR.	SPECIFICATION	AMOUNT
Orfix 10	OR9905-4	Black	1 bucket = 4 kg
Orfix 10	OR9905-2	Black	1 sack = 20 kg
Orfix 10	OR9906-4	Light*	1 bucket = 4 kg
Orfix 10	OR9906-2	Light*	1 sack = 20 kg



ORFIX 13S – PASTE

It is silicate-base, inorganic, solvent-free, fire-resistant, odorless and non-hazardous to health adhesive of high adhesive power. Can be mixed with max. 5% water addition. For joining fireclay elements, insulation and absorbent fireclay materials, clinker and various fire-resistant construction materials. For use in areas permanently exposed to the temperatures up to 1200 °C. .

ARTICLE	ARTICLE NR.	SPECIFICATION	AMOUNT
Orfix13S	OR9904	light	1 bucket = 5 kg

TIP



STORE FROST PROTECTED!

SPECIAL ACCESSORIES

REDUCTION LIQUID

Reduction liquid for adhesive mortar "Das Original" and "Creme".

ARTICLE	ARTICLE NR.	SPECIFICATION	AMOUNT
Reduction liquid	OR110E	for adhesive mortar	400 ml



STORE FROST PROTECTED!

READY STOVE-SETTING MATERIALS

CAST FIRECLAY BOARDS*, ELBOWS, RADII BOARD AND PILASTER STRIPS



The ORTNER fireclay products are perfect for casing the accumulation core in the hypocaust system: fast accumulation and conductivity of energy radiating from the inner accumulator thanks to heightened heat conductivity – designed for the load-bearing systems with a heavy core. For use in areas permanently exposed to the temperatures up to 450 °C. For fixing one can use adhesive mortar, adhesive mortar Crème or the ORTNER pressure-sensitive adhesive or by means of the ORTNER fast montage screws.

CAST FIRECLAY BOARDS*

ARTICLE	ARTICLE NR.	SPECIFICATION	AMOUNT
Cast fireclay board	OR700	Normformat 500 x 1.200 x 25 mm	1 pc. = 33 kg, 1 palette = 25
Cast fireclay board	OR7000	Normformat 500 x 1.000 x 25 mm	1 pc. = 28 kg; 1 palette = 25
Fireclay pilaster strip	OR772	96 x 1200 x 25 mm	1 pc. = 6,4 kg
Fireclay pilaster strip	OR773	122 x 1200 x 25 mm	1 pc. = 8 kg
Fireclay pilaster strip	OR774	163 cm x 1200 x 25 mm	1 pc. = 10,7 kg



ELBOWS AND FIRECLAY PILASTER STRIPS*

!Attention: 1000mm elements are available exclusively on order!

ARTICLE	ARTICLE NR.	SPECIFICATION	WEIGHT
(A) Fireclay elbow 90°	OR750	thickness 25 mm, 100x125x500 mm	6,4 kg
(A) Fireclay elbow 90°	OR750-1	thickness 25 mm, 100x125x1000 mm	12,8 kg
(B) Fireclay elbow 135°	OR760	thickness 25 mm, 100x125x500 mm	6,4 kg
(B) Fireclay elbow 135°	OR760-1	thickness 25 mm, 100x125x1000 mm	12,8 kg
✓ (C) Fireclay pilaster strip	OR791	thickness 25 mm, height 500 mm, rounding angle	6,83 kg
✓ (C) Fireclay pilaster strip	OR791-1	thickness 25 mm, height 1000 mm, rounding angle	13,66 kg
✓ (D) Fireclay pilaster strip	OR792	thickness 25 mm, height 500 mm, rounding angle	7,69 kg
✓ (D) Fireclay pilaster strip	OR792-1	thickness 25 mm, height 1000 mm, rounding angle	15,38 kg
✓ (E) Fireclay pilaster strip	OR793	thickness 25 mm, height 500 mm, rounding angle	10,75 kg
✓ (E) Fireclay pilaster strip	OR793-1	thickness 25 mm, height 1000 mm, rounding angle	21,5 kg
✓ (F) Fireclay elbow 90°	OR794	thickness 25 mm, 150x150x500, radius = 70 mm	6,88 kg
(F) Fireclay elbow 90°	OR794-1	thickness 25 mm, 150x150x1000, radius = 70 mm	13,76 kg
(G) S-shaped fireclay pilaster strip	OR795	thickness 25 mm, 150x150x H = 500 mm, R1 = 100 mm, R2 = 125 mm	7,82 kg
(G) S-shaped fireclay pilaster strip	OR795-1	thickness 25 mm, 150x150x H = 1000 mm, R1 = 100 mm, R2 = 125 mm	15,64 kg

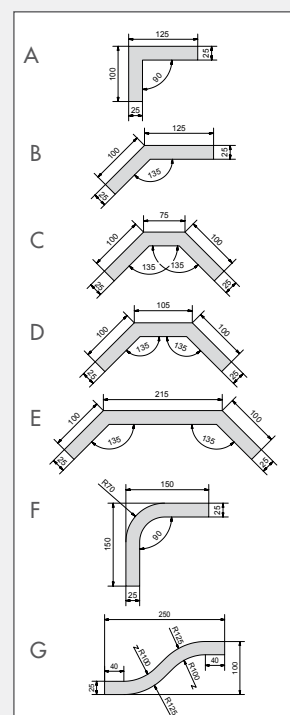

✓ = available while stocks last

CAST FIRECLAY

RADII *

TIP

CAST FIRECLAY BOARD VIVEG

The ORTNER cast fireclay board VIVEG is an elastically cast fireclay board meant for constructing a stove shell of any shape. Integrated reinforcement enables free forming. For fixing one can use adhesive mortar, adhesive mortar Crème or the ORTNER pressure-sensitive adhesive.

NEW PRICE



ARTICLE	ARTICLE NR.	SPECIFICATION	WEIGHT
Cast fireclay board VIVEG	OR720	625 x 500 x 25 mm	13 kg

ONE BOARD FOR ALL RADIUS

CAST FIRECLAY BOARDS RADII*

ARTICLE	ARTICLE NR.	SPECIFICATION	CONTOUR	RADIAN	WEIGHT	SEG.	
V	(A) Cast fireclay board	OR70100	R 100, 500 mm	628 mm	314 mm	8,6 kg	2
V	(A) Cast fireclay board	OR70100-1 **	R 100, 1.000 mm	628 mm	314 mm	17,2 kg	2
V	(B) Cast fireclay radius	OR70125	R 125, 500 mm	785 mm	393 mm	10,8 kg	2
V	(C) Cast fireclay radius	OR70150	R 150, 500 mm	942 mm	471 mm	12,9 kg	2
V	(C) Cast fireclay radius	OR70150-1 **	R 150, 1.000 mm	942 mm	471 mm	25,8 kg	2
V	(D) Cast fireclay radius	OR70200	R 200, 500 mm	1.257 mm	628 mm	17,2 kg	2
V	(D) Cast fireclay radius	OR70200-1 **	R 200, 1.000 mm	1.257 mm	628 mm	34,4 kg	2
V	(E) Cast fireclay radius	OR70250	R 250, 500 mm	1.571 mm	785 mm	21,5 kg	2
	(E) Cast fireclay radius	OR70250-1 **	R 250, 1.000 mm	1.571 mm	785 mm	43,1 kg	2
	(F) Cast fireclay radius	OR70300	R 300, 500 mm	1.885 mm	628 mm	17,2 kg	2
	(F) Cast fireclay radius	OR70300-1 **	R 300, 1.000 mm	1.885 mm	628 mm	34,4 kg	2
V	(G) Cast fireclay radius	OR70350	R 350, 500 mm	2.199 mm	733 mm	18,7 kg	3
V	(G) Cast fireclay radius	OR70350-1 **	R 350, 1.000 mm	2.199 mm	733 mm	37,47 kg	3
	(H) Cast fireclay radius	OR70400	R 400, 500 mm	2.513 mm	628 mm	17,2 kg	4
	(H) Cast fireclay radius	OR70400-1 **	R 400, 1.000 mm	2.513 mm	628 mm	34,4 kg	4
V	(I) Cast fireclay radius	OR70450	R 450, 500 mm	2.827 mm	707 mm	19,4 kg	4
V	(I) Cast fireclay radius	OR70450-1 **	R 450, 1.000 mm	2.827 mm	707 mm	38,8 kg	4
	(J) Cast fireclay radius	OR70500	R 500, 500 mm	3.142 mm	628 mm	17,2 kg	5
	(J) Cast fireclay board	OR70500-1 **	R 500, 1.000 mm	3.142 mm	628 mm	34,4 kg	5
V	(K) Cast fireclay radius	OR70550	R 550, 500 mm	3.456 mm	691 mm	19 kg	5
V	(K) Cast fireclay radius	OR70550-1 **	R 550, 1.000 mm	3.456 mm	691 mm	38 kg	5
	(L) Cast fireclay radius	OR70600	R 600, 500 mm	3.770 mm	628 mm	17,2 kg	6
	(L) Cast fireclay radius	OR70600-1 **	R 600, 1.000 mm	3.770 mm	628 mm	34,4 kg	6
V	(M) Cast fireclay radius	OR70650	R 650, 500 mm	4.084 mm	681 mm	18,7 kg	6
V	(M) Cast fireclay radius	OR70650-1 **	R 650, 1.000 mm	4.084 mm	681 mm	37,4 kg	6
	(N) Cast fireclay radius	OR70700	R 700, 500 mm	4.398 mm	628 mm	17,2 kg	7
	(N) Cast fireclay radius	OR70700-1 **	R 700, 1.000 mm	4.398 mm	628 mm	34,4 kg	7
V	(O) Cast fireclay radius	OR70750	R 750, 500 mm	4.712 mm	673 mm	18,5 kg	7
V	(O) Cast fireclay radius	OR70750-1 **	R 750, 1.000 mm	4.712 mm	673 mm	36,9 kg	7
	(P) Cast fireclay radius	OR70800	R 800, 500 mm	5.027 mm	628 mm	17,2 kg	8
	(P) Cast fireclay radius	OR70800-1 **	R 800, 1.000 mm	5.027 mm	628 mm	34,4 kg	8
V	(Q) Cast fireclay radius	OR70900	R 900, 500 mm	5.655 mm	628 mm	17,2 kg	9
V	(Q) Cast fireclay radius	OR70900-1 **	R 900, 1.000 mm	5.655 mm	628 mm	34,4 kg	9
V	(R) Cast fireclay radius	OR71000	R 1.000, 500 mm	6.283 mm	628 mm	17,2 kg	10
V	(R) Cast fireclay radius	OR71000-1 **	R 1.000, 1.000 mm	6.283 mm	628 mm	34,4 kg	10

* All elements can be produced in cast concrete on order.

** The 1000mm radii are available exclusively on order.

V = available while stocks last

CAST FIRECLAY BOARDS* RADII, RADII OVERVIEW

ARTICLE	ARTICLE NR.	SPECIFICATION	CONTOUR	RADIAN	WEIGHT	SEC.	
V	(S) Cast fireclay radius	OR71250	R 1.250, 500 mm	7.854 mm	654 mm	17,9 kg	12
V	(S) Cast fireclay radius	OR71250-1 **	R 1.250, 1.000 mm	7.854 mm	654 mm	35,9 kg	12
V	(T) Cast fireclay radius	OR71500	R 1.500, 500 mm	9.425 mm	628 mm	17,2 kg	15
V	(T) Cast fireclay radius	OR71500-1 **	R 1.500, 1.000 mm	9.425 mm	628 mm	34,4 kg	15
V	(U) Cast fireclay radius	OR72000	R 2.000, 500 mm	12.566 mm	628 mm	17,2 kg	20
V	(U) Cast fireclay radius	OR72000-1 **	R 2.000, 1.000 mm	12.566 mm	628 mm	34,4 kg	20
V	(V) Cast fireclay radius	OR73000	R 3.000, 500 mm	18.850 mm	628 mm	17,2 kg	30
V	(V) Cast fireclay radius	OR73000-1 **	R 3.000, 1.000 mm	18.850 mm	628 mm	34,4 kg	30
V	(W) Cast fireclay radius	OR74000	R 4.000, 500 mm	25.133 mm	628 mm	17,2 kg	40
V	(W) Cast fireclay radius	OR74000-1 **	R 4.000, 1.000 mm	25.133 mm	628 mm	34,4 kg	40

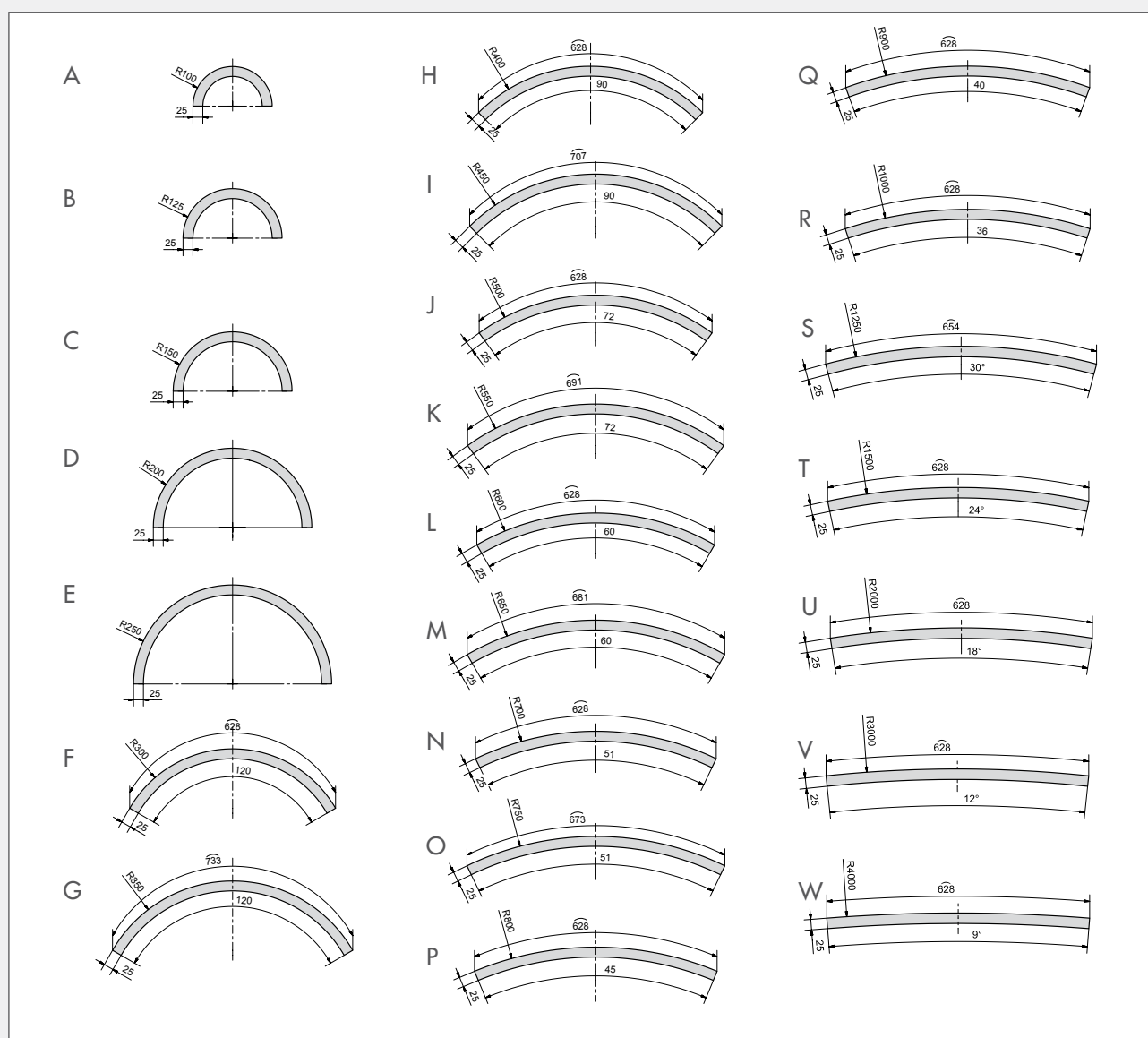

V = available while stocks last

* All elements can be produced in cast concrete on order.
** The 1000mm radii are available exclusively on order.

STOVE BOARDS, ELBOWS AND RADII

STOVE BOARDS, ELBOWS AND RADII

The ORTNER stove boards have been designed for the requirements of the NEW housing technology. Due to their exceptional accumulation, the heat is accumulated more regularly and longer. The ORTNER stove boards guarantee low surface temperatures and longer accumulation time, which are needed in **energy saving and passive houses**. For fixing one can use adhesive mortar, adhesive mortar Crème or the ORTNER pressure-sensitive adhesive. Recommended for use in areas **exposed to the temperatures up to 350°C**.

ARTICLE	ARTICLE NR.	SPECIFICATION	AMOUNT
(A) Stove board	OR605	LxHxB 500 x 250 x 35 mm	1 pc. = 6,2 kg, 1 palette = 80 pc.
(A) Stove board	OR601	LxHxB 1.000 x 250 x 35 mm	1 pc. = 12,4 kg, 1 palette = 40 pc.
(A) Stove board	OR602	LxHxB 1.000 x 500 x 35 mm	1 pc. = 22,5 kg, 1 palette = 20 pc.
(A) Stove board	OR603	LxHxB 750x 500 x 35 mm	1 pc. = 16,9 kg, 1 palette = 20 pc.
(B) Elbow 90°	OR650	LxLxHxB 250 x 125 x 250 x 35 mm	1 pc. = 3,6 kg, 1 palette = 40 pc.
(B) Elbow 90°	OR652	LxLxHxB 250 x 125 x 500 x 35 mm	1 pc. = 7,2 kg, 1 palette = 40 pc.
(C) Elbow 90°	OR651	LxLxHxB 700 x 350 x 500 x 35 mm	1 pc. = 24,5 kg, 1 palette = 14 pc.
(D) Elbow 135°	OR660	LxLxHxB 250 x 125 x 250 x 35 mm	1 pc. = 4,7 kg, 1 palette = 36 pc.
(D) Elbow 135°	OR661	LxLxHxB 250 x 125 x 500 x 35 mm	1 pc. = 9,4 kg, 1 palette = 36 pc.
(E) Radius R22	OR60220	HxB 500 x 35 mm	1 pc. = 14,5 kg, 1 palette = 8 pc.
(F) Radius R30	OR60300	HxB 250 x 35 mm	1 pc. = 6,4 kg, 1 palette = 17 pc.
(G) Radius R33	OR60330	HxB 500 x 35 mm	1 pc. = 14,9 kg, 1 palette = 16 pc.
(H) Radius R40	OR60400	HxB 250 x 35 mm	1 pc. = 6,6 kg, 1 palette = 22 pc.
(I) Radius R44	OR60440	HxB 500 x 35 mm	1 pc. = 15,1 kg, 1 palette = 20 pc.
(J) Radius R50	OR60500	HxB 250 x 35 mm	1 pc. = 6,2 kg, 1 palette = 25 pc.
(K) Radius R55	OR60550	HxB 500 x 35 mm	1 pc. = 15,2 kg, 1 palette = 23 pc.
(L) Radius R60	OR60600	HxB 250 x 35 mm	1 pc. = 6,2 kg, 1 palette = 26 pc.
(M) Radius R65	OR60650	HxB 500 x 35 mm	1 pc. = 15,1 kg, 1 palette = 23 pc.

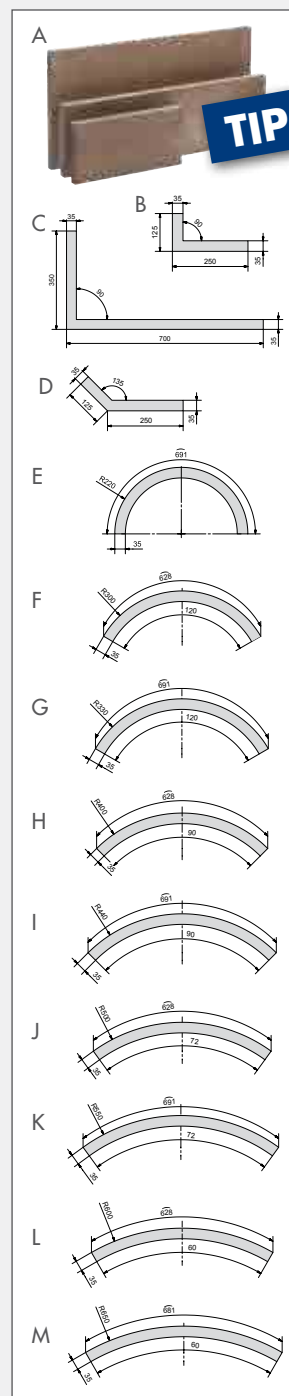

BEARING STONE

NEW

The ORTNER L-shaped bearing stone allows a perfect covering of the shell made out of the ORTNER stove boards.

ARTICLE	ARTICLE NR.	SPECIFICATION	AMOUNT
Bearing stone	OR680	L-shaped bearing stone, thickness 35 mm 100 x 70 x 500 mm	1 pc. = 3,5 kg, 1 palette = 40 pcs.



ACCUMULATION BOARDS

ACCUMULATION BOARD*

NEW PRICE

Accumulation board is meant for use as an additional heat accumulator for metal heating inserts. For fixing one can use adhesive mortar, adhesive mortar Crème or the ORTNER pressure-sensitive adhesive.

ARTICLE	ARTICLE NR.	SPECIFICATION	AMOUNT
Accumulation board	OR607	LxHxB 600 x 300 x 40 mm	1 pc. = 18,5 kg, 1 palette = 36 pcs.

* Accumulation board must not be used for constructing shells

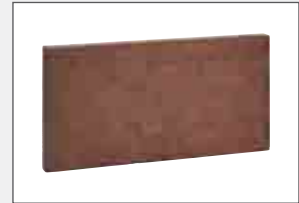

SPECIAL CONSTRUCTION ELEMENTS

FIRECLAY LINTEL BEAM

The ORTNER fireclay lintel beam is a support for openings on the inside and the outside of the hypocaust (excl. the combustion chamber) and guarantees the optimal weight distribution of the building elements. The static load-bearing capacity is enabled by an integrated galvanized rebar cage. For fixing one can use adhesive mortar, adhesive mortar "Crème" or the ORTNER pressure-sensitive adhesive.

ARTICLE	ARTICLE NR.	SPECIFICATION	WEIGHT
Fireclay lintel beam	OR790	600 x 150 x 1.200 mm	15 kg



FIRECLAY FRAMES AND LIDS

ARTICLE	ARTICLE NR.	SPECIFICATION	WEIGHT
(A) Fireclay frame and lid	OR7813RSet	Round frame 220x220 mm and straight, round lid ø 135 mm	3,72 kg
(B) Fireclay frame and lid	OR7813Set	Square frame 220x220 mm and straight, square lid ø 135 mm	2,76 kg
(C) Fireclay frame and lid	OR7818Set	Square frame 300x300 mm and straight, square lid ø 190 mm	5,26 kg
(D) Fireclay lid spare part	OR7813E	220x220 mm and straight	
(D) Fireclay lid spare part	OR7818E	300x300 mm and straight,	

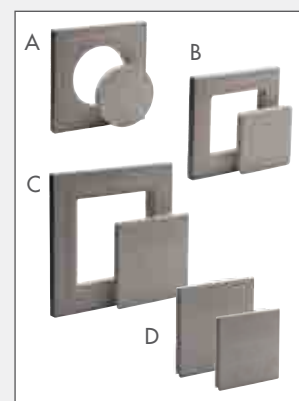

FIRECLAY LINKING ELEMENT

ARTICLE	ARTICLE NR.	SPECIFICATION	WEIGHT
Fireclay linking element	OR70-160	160 ø, cast iron/iron pipe	4,6 kg
Fireclay linking element	OR70-180	180 ø, cast iron/iron pipe	5,4 kg
Fireclay linking element	OR70-180 HT	180 ø, HT iron pipe	7,7 kg
Fireclay linking element	OR70-200 HT	200 ø, HT iron pipe	8,3 kg



SPECIAL FIRECLAY ELEMENTS

3S CLEANING LID

ARTICLE	ARTICLE NR.	SPECIFICATION	WEIGHT
3S Cleaning lid	OR3S-26ST	250 x 200 x 64 mm	1 piece



UNIVERSAL BOARDS, ELBOWS AND RADII

Universal board is a waterproof, purely mineral construction board meant for constructing plastered surfaces in lightweight construction, resistant to temperatures up to 70°C.

The reduced thickness of 12,5 mm enables constructing lightweight plastered surfaces. The elements are double reinforced and are distinguished by their durability. Not suitable for statically loaded coverings. For fixing one can use adhesive mortar, adhesive mortar Crème or the ORTNER pressure-sensitive adhesive or the ORTNER fast montage screws.

UNIVERSAL BOARDS

ARTICLE	ARTICLE NR.	SPECIFICATION	AMOUNT
Universal board	OR710H	1.250 x 870 x 12,5 mm	1 pc. = 16 kg; 1 palette = 25 pcs.
Universal board	OR711H	1.250 x 430 x 12,5 mm	1 pc. = 8 kg; 1 palette = 50 pcs.



UNIVERSAL RADII

!Attention: Universal radii are available exclusively on order!

ARTICLE	ARTICLE NR.	SPECIFICATION	AMOUNT
(A) UP Radius 10	OR70100H	500 mm	3,9 kg
(B) UP Radius 15	OR70150H	500 mm	6,1 kg
(C) UP Radius 20	OR70200H	500 mm	4,1 kg
(D) UP Radius 25	OR70250H	500 mm	5,45 kg
(E) UP Radius 30	OR70300H	500 mm	5,6 kg
(F) UP Radius 35	OR70350H	500 mm	4,8 kg
(G) UP Radius 40	OR70400H	500 mm	6,45 kg
(H) UP Radius 50	OR70500H	500 mm	6,5 kg
(I) UP Radius 60	OR70600H	500 mm	7,9 kg
(J) UP Radius 70	OR70700H	500 mm	8,2 kg
(K) UP Radius 100	OR701000H	500 mm	9,1 kg

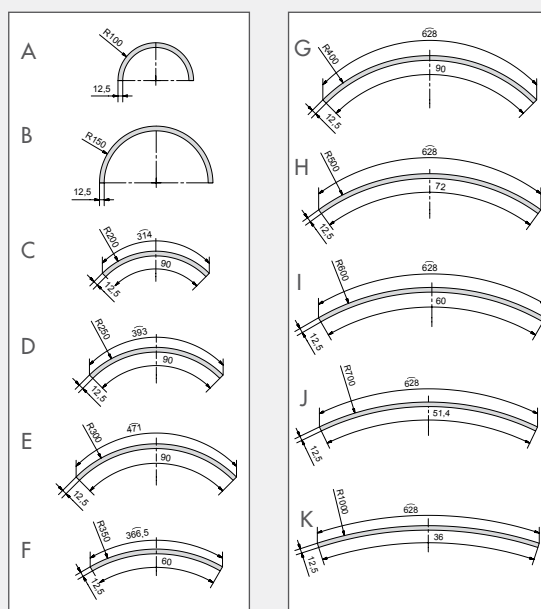

ELBOWS

ARTICLE	ARTICLE NR.	SPECIFICATION	AMOUNT
(A) Inner elbow	OR751	90°, 500 mm	4,5 kg
(A) Inner elbow	OR751-1	90°, 1.000 mm	9 kg
(B) Outer elbow	OR752	90°, 500 mm	4,5 kg
(B) Outer elbow	OR752-1	90°, 1.000 mm	9 kg
(C) Inner elbow	OR761	135°, 500 mm	4,5 kg
(C) Inner elbow	OR761-1	135°, 1.000 mm	9 kg
(D) Outer elbow	OR762	135°, 500 mm	4,5 kg
(D) Outer elbow	OR762-1	135°, 1.000 mm	9 kg

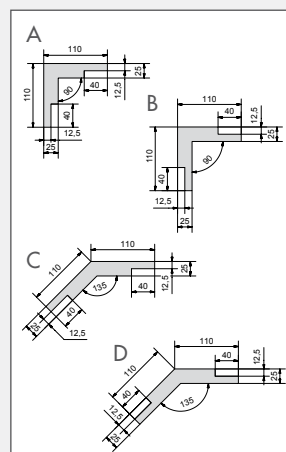

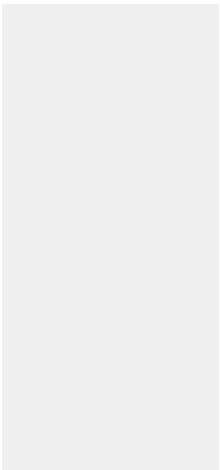

ORTNER INSIDE COMBUSTION CHAMBER

The ORTNER Grundöfen (GO = basic stoves) and the ceramic heat accumulating system are the core of the heat accumulating tiled stove! Flexible, fast and clean installation as well as the variety of possibilities of connecting a GO and the heat accumulating system are but a few of advantages of the modern ORTNER tiled stove!

The ORTNER GO fulfills all the low heat load requirements of the low-energy houses and so can be adjusted to and designed for each house type.

Moreover, the GOs comply with the national regulations §15a as well as the regulations of the Emissions Protection Ordinances (BIMSchV level 2) and of the Swiss Pure Air Act (Luftaltheverordnung; LRV). The ORTNER GOs –bring therefore not only cozy and economic warmth into one's home, but also contribute to environmental protection in a special way.

Characteristic for the ORTNER GOs is the high portion of ceramic heat accumulating mass. At least 80% of the GO consists of the accumulating mass, which allows the stove to become accumulating system in itself.

WHY ORTNER COMBUSTION CHAMBERS

-  Stove = Accumulation mass
-  ORTNER basic stove consists of min. 80% aus ceramic accumulation mass
-  Ecological (lowest emissions standards)
-  Best accumulation characteristics
-  Maximum accumulation on minimum space utilization
-  qualified for lower-energy houses
-  Changable combustion chamber parts
-  Accurate planing with less material cull
-  assured rapid setting
-  dust-free setting
-  100 % Austrian Quality

| THE NEW |

GOR44



NEW

KMS 240 KAM

GOR44	KMS 240	KAM
Amount of wood	6 kg	5 kg
Accumulated heat	19,2 kWh	16 kWh
Heating efficiency/h with KMS-System for 8 hour refilling interval	2,4 kW	-
Heating efficiency/h with KMS-System for 6 hour refilling interval	-	2,6 kW
Weight of the firebox	180 kg	180 kg
Efficiency	> 82 %	>81 %
Air supply regulation	man. oder autom.	man. oder autom.

Emission standards:

LIMIT VALUES	CO (mg/MJ)	NOx (mg/MJ)	OGC (mg/MJ)	Staub (mg/MJ)	η (%)
	Carbon monoxide	Nitrogen oxide	organic carbon	dust	efficiency
Austria 15a	1100	150	80	60	78
Ecolabel UZ 37	700	120	50	30	80
Germany BIMSchV 2. Grade	830	-	-	27	70-80
Switzerland, Clean Air Act (LRV)	1000	-	-	50	-

The measured emission values acc. to EN 13229:

GOR44 Messwerte	CO (mg/MJ)	NOx (mg/MJ)	OGC (mg/MJ)	Staub (mg/MJ)	η (%)
	630	100	34	23	83

GOR44

- | 01 | "Steel door frame" – The optimized socket construction
- | 02 | „Compatible“ – The exchangeable firebox parts.
- | 03 | "Flexible" – More space thanks to multiple possibilities of air supply connection.

| THE DOUBLE SIDED |

GO8T



NEW

KMS 240 KMS 300

GO8T	KMS 240	KMS 300
Amount of wood	5 kg	5 kg
Accumulated heat	16 kWh	16 kWh
Heating efficiency/h with KMS-System for 8 hour refilling interval	-	2 kW
Heating efficiency/h with KMS-System for 6 hour refilling interval	2,7 kW	-
Weight of the firebox	227 kg	227 kg
Efficiency	84,1 %	84,1 %
Air supply regulation	man. od. autom.	man. od. autom.

Emission standards:

LIMIT VALUES	CO (mg/MJ)	NOx (mg/MJ)	OGC (mg/MJ)	Staub (mg/MJ)	η (%)
	Carbon monoxide	Nitrogen oxide	organic carbon	dust	efficiency
Austria 15a	1100	150	80	60	78
Ecolabel UZ 37	700	120	50	30	80
Germany BIMSchV 2. Grade	830	-	-	27	70-80
Switzerland, Clean Air Act (LRV)	1000	-	-	50	-

The measured emission values acc. to EN 13229:

GO8T Messwerte	CO (mg/MJ)	NOx (mg/MJ)	OGC (mg/MJ)	Staub (mg/MJ)	η (%)
	691	88	32	18	84

GO8T

The ORTNER GO 8T is the first ceramic tunnel oven (with glass on both sides you can see through it) in the ORTNER range and fulfills the requirements of the modern oven setting. Two sets of GO doors allow the impressive sight of flaming fire from, for instance, two separate living areas.

- Amount of wood: 5 kg wood
- Total weight ca. 227 kg
- 2 sets of GO doors with double glazing
- Frame for the perfect installation of the GO body
- Automatic or manual control possible

Despite the two glasses, in the model we have accomplished bringing the heat accumulating ability in harmony with optical added-value! An accomplishment it is, as until now, no ceramic heat accumulating tiled stove has been manufactured as a tunnel.

"Flexible"
More space thanks to multiple possibilities of air supply connection.

| THE CLASSIC ONE |

GO8



KMS 240 KMS 300



GO8	KMS 240	KMS 300
Amount of wood	8 kg	8 kg
Accumulated heat	25,6 kWh	25,6 kWh
Heating efficiency/h with KMS-System for 12 hour refilling interval	-	2,13 kW
Heating efficiency/h with KMS-System for 8 hour refilling interval	3,2 kW	-
Weight of the firebox	222 kg	222 kg
Efficiency	88,1 %	88,1 %
Air supply regulation	man. od. autom.	man. od. autom.

Emission standards:

LIMIT VALUES	CO (mg/MJ)	NOx (mg/MJ)	OGC (mg/MJ)	Staub (mg/MJ)	η (%)
	Carbon monoxide	Nitrogen oxide	organic carbon	dust	efficiency
Austria 15a	1100	150	80	60	78
Ecolabel UZ 37	700	120	50	30	80
Germany BIMSchV 2. Grade	830	-	-	27	70-80
Switzerland, Clean Air Act (LRV)	1000	-	-	50	-

The measured emission values acc. to EN 13229:

GO8 Messwerte	CO (mg/MJ)	NOx (mg/MJ)	OGC (mg/MJ)	Staub (mg/MJ)	η (%)
	337	90	13	12	88

GO8

The basic oven (Grundofen) 8 in two different variants connects the exceptional heat accumulating abilities of the ORTNER basic ovens (Grundöfen) with minimal emissions and extraordinary durability!

The oven has been developed with regard to the decreasing heating needs of new buildings. The installation of the compact basic oven is the trusty modular construction. Inside the combustion chamber the cooling air supply guarantees the optimal combustion. The ceramic heat accumulating system in the form of KMS 240 or 300 can be mounted onto the top, 360° rotatable KMS cover.

- Amount of wood: 8 kg wood
- Total weight 222 kg
- GO doors with double glazing
- Frame for perfect installation of the GO body
- Automatic or manual control possible

"Flexible"
More space thanks to multiple possibilities of air supply connection.

| THE POWERFUL |

GO15



KMS 300 KMS 300



GO15	KMS 300	KMS 300
Amount of wood	15 kg	15 kg
Accumulated heat	48 kWh	48 kWh
Heating efficiency/h with KMS-System for 12 hour refilling interval	-	4 kW
Heating efficiency/h with KMS-System for 8 hour refilling interval	6 kW	-
Weight of the firebox	450 kg	450 kg
Efficiency	92,1 %	92,1 %
Air supply regulation	automatisch	automatisch

Emission standards:

LIMIT VALUES	CO (mg/MJ)	NOx (mg/MJ)	OGC (mg/MJ)	Staub (mg/MJ)	η (%)
	Carbon monoxide	Nitrogen oxide	organic carbon	dust	efficiency
Austria 15a	1100	150	80	60	78
Ecolabel UZ 37	700	120	50	30	80
Germany BIMSchV 2. Grade	830	-	-	27	70-80
Switzerland, Clean Air Act (LRV)	1000	-	-	50	-

The measured emission values acc. to EN 13229:

GO15 Messwerte	CO (mg/MJ)	NOx (mg/MJ)	OGC (mg/MJ)	Staub (mg/MJ)	η (%)
	229	102	34	15	92

GO15

The ORTNER basic oven (Grundofen) 15 has been tailored to the newest emission requirements and optimized in the area of combustion technology. The installation of the compact basic oven is the trusty modular construction. Inside the combustion chamber the cooling air supply guarantees the optimal combustion. The ceramic heat accumulating system in the form of KMS 300 can be connected on the side.

- Wood amount: 15 kg wood
- Total weight ca. 450 kg
- GO doors with double glazing
- Frame for perfect installation of the GO body
- Automatic control

SAFETY WITH ORTNER GMBH

ORTNER Inside is planned individually by means of the ORTNER calculation program. By using the program developed by independent research institute the safety of the optimal function is guaranteed.

**REGISTRATION AND LOGIN ON:
WWW.ORTNER-CC.AT/HAFNERBEREICH**



Optimization of the efficiency up to > 90 %



Planning of ORTNER Inside projects



Calculation documentation



Issue of relevant calculation data



Complies with the required standards (e.g.: chimney functionality certification)



FREE ONLINE-VERSION (for specialized companies)

Relevant calculation data:



Temperature



Pressure



Efficiency



Total heat accumulating mass



Technical documentation



Final findings

AWARDED WITH THE AUSTRIAN ECOLABEL

Emission low basic oven (Grundofen) with optimal energy yield!



The ORTNER INSIDE basic ovens (Grundöfen) have been awarded the Austrian Ecolabel, which certifies that the emission- and dust-low ORTNER INSIDE basic ovens comply with the Directive UZ 37.

Find more infos on:
www.ortner-cc.at

ORTNER
KACHELOFEN MIT SYSTEM

ORTNER COMBUSTION CHAMBERS

ORTNER GOR44 – WITH SMALL DOORS

NEW



Maximal efficiency on minimal space. Due to the direct connection of the accumulation core or the stove cover with the KMS ceramic accumulation module (p. 39), we offer the flexibility of the various modular elements developed for Rundofen. Sophisticated whirl technology guarantees a complete, and as a result, clean combustion. The height of the attached basic frame can be regulated; there is automatic and manual control available.

CHANGEABLE COMBUSTION CHAMBER PARTS

GOR44	KMS 240	KAM
Amount of wood	6 kg	5 kg
Accumulated heat	19,2 kWh	16 kWh
Heating efficiency/h with KMS-System for 8 hour refilling interval	2,4 kW	-
Heating efficiency/h with KMS-System for 6 hour refilling interval	-	2,6 kW
Weight of the firebox	180 kg	180 kg
Efficiency	> 82 %	>81 %
Air supply regulation	man. oder autom.	man. oder autom.

STEP 1: CHOOSING COMBUSTION CHAMBER INCL. DOORS

ARTICLE	ARTICLE NR.	SPECIFICATION
(A) ORTNER GOR44 manual control	GOR44KH	GOR44 small doors 31,5 x 50,5 * standard
(A) ORTNER GOR44 automatic	GOR44KA	GOR44 small doors 31,5 x 50,5 * standard

STEP 1.1: ALTERNATIVE DOOR CHOICE

NEW

ARTICLE	ARTICLE NR.	SPECIFICATION
B) Additional function: self closing and/or self locking	OR-APTÜR	Self closing and/or self locking doors

STEP 1.1: CHOOSING GLASS

ARTICLE	ARTICLE NR.	SPECIFICATION
(C) Gold frame	OR-GTO-APK2	for small, straight doors
V (D) Gold points	OR-GTO-APK3	for small, straight doors
(E) White frame	OR-GTO-APK4	for small, straight doors
V (F) White points	OR-GTO-APK5	for small, straight doors

STEP 2: CHOOSING BEZEL

ARTICLE	ARTICLE NR.	SPECIFICATION
V (G) Steel bezel straight	OR-SBK	for small doors
(H) Steel bezel straight, wide	OR-SBKR	for small doors, wide bezel
V (I) Steel bezel rounded	OR-SBK6	ø 600 mm, for small doors, rounded
(J) Steel bezel rounded, wide	OR-SBK6R	ø 600 mm, for small doors, rounded, wide

STEP 3: CHOOSING THE CONTROL METHOD

ARTICLE	ARTICLE NR.	SPECIFICATION
(K) Stove control LED	OR-STL	Combustion control with LED screen
(L) Stove control Bluetooth (APP)	OR-STB	Combustion control with LED screen and data transfer module (APP) **

* Standard features: glass with a black full-framing and a handle: „silver cone“, excl. bezel.

** The Bluetooth control APP is available at www.ortner-cc.at or at your APP store.

V = available while stocks last

ORTNER GOR44

STEP 4: CHOOSING EXTERNAL AIRFLOW

ARTICLE	ARTICLE NR.	SPECIFICATION	SPEZIFIKATION
Automatic control	(M) Airflow I LED/APP	OR-LRA1-LB	Automatic airflow control consists of combustion air flap with actuator \varnothing 125, with flexible aluminum pipe, hose clip (2 pcs.); air grid
Automatic control	(N) Airflow II LED/APP	OR-LRA2-LB	Automatic airflow control with combustion air box and actuator \varnothing 125
Manual control	(O) External airflow I	OR-LRH1	Outside size 14,5 x 32,5 cm, RO manual airflow control consists of rectangular air box, air grid, flexible aluminum pipe, hose clip (2
Manual control	(P) External airflow II	OR-LRH2	Outside size 23 x 23 cm, RO manual airflow control consists of rectangular air box, air grid, flexible aluminum pipe, hose clip (2 pcs.)

STEP 4.1: ACCESSORIES SET

ARTICLE	ARTICLE NR.	SPECIFICATION
(Q) Accessories set \varnothing 600	OR-BSET	Page 37
(Q) Accessories set \varnothing 700	OR-BSET70	Page 37

STEP 5: CHOOSING FLEX-SPEICHER SYSTEM

PRODUKTBEZEICHNUNG	SPEZIFIKATION
(R) Variant 1	Accumulation modules (Page 39)
(S) Variant 2	Cover KMS \varnothing 180 KMS 300, \varnothing 160 KWS 240 (Page 39)

COMBUSTION CHAMBER	AMOUNT SINGL KAM MODULES	AMOUNT DOUBLE KAM	\varnothing 120	OPENINGS \varnothing 180	\varnothing 200	HEIGHT AT THE OPENING \varnothing 200
GOR44	5	x	x	x	x	800
GOR44	6	x	x	x	x	900
GOR44	7	x	x	x	x	1000

The numbers show the min. or max. amount of accumulation modules*) The accumulation modules height when using the side opening \varnothing 200.

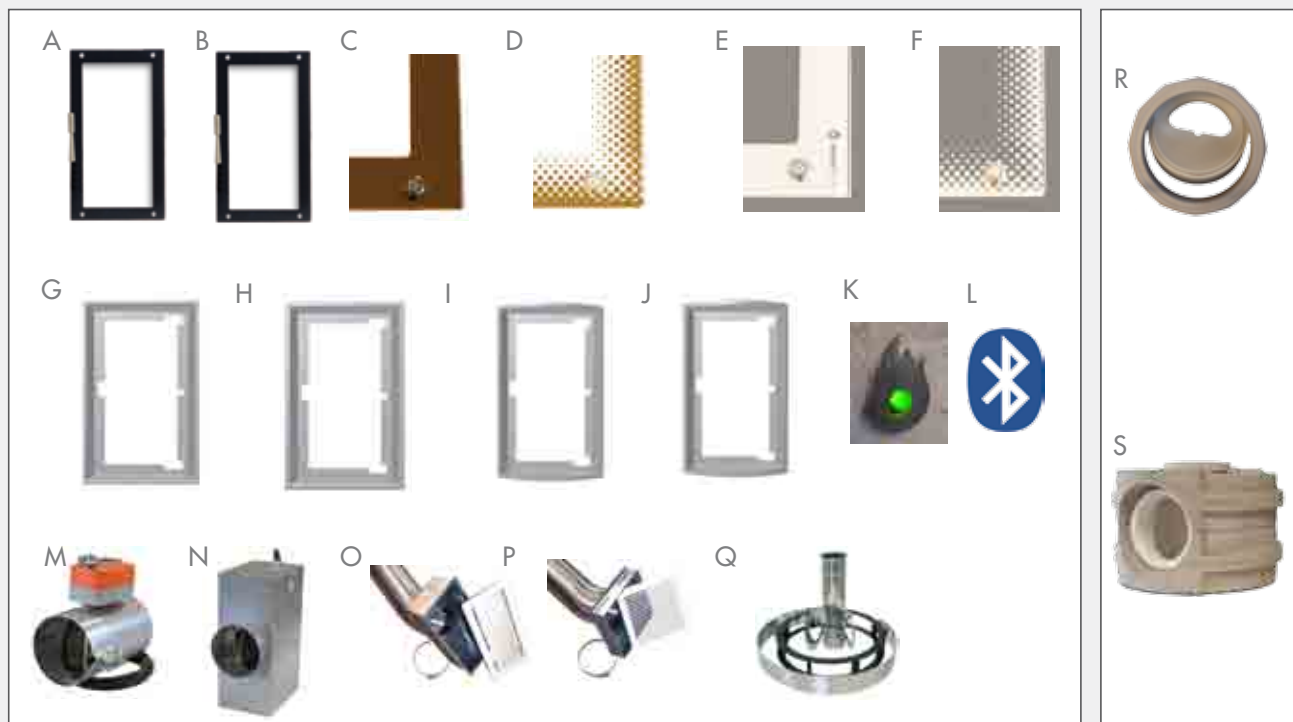

ORTNER GOR44 – WITH LARGE DOORS



GOR44 RA

Maximal efficiency on minimal space. Due to the direct connection of the accumulation core or the stove cover with the KMS ceramic accumulation module (p. 39), we offer the flexibility of the various modular elements developed for Rundofen. Sophisticated whirl technology guarantees a complete, and as a result, clean combustion. The height of the attached basic frame can be regulated – there is automatic and manual control available.

GOR44	KMS 240	KAM
Amount of wood	6 kg	4,5 kg
Accumulated heat	19,2 kWh	14,4 kWh
Heating efficiency/h with KMS-System for 8 hour refilling interval	2,4 kW	-
Heating efficiency/h with KMS-System for 6 hour refilling interval	-	2,4 kW
Weight of the firebox	ca. 150 kg	ca. 150 kg
Efficiency	> 82 %	>81 %
Air supply regulation	man. oder autom.	man. oder autom.

STEP 1: CHOOSING COMBUSTION CHAMBER INCL. DOORS

ARTICLE	ARTICLE NR.	SPECIFICATION
(A) ORTNER GOR44 manual control	GOR44GH	GOR44 large doors straight 43 x 51 * standard
(A) ORTNER GOR44 automatic	GOR44GA	GOR44 large doors straight 43 x 51 * standard
(B) ORTNER GOR44 manual control	GOR44RH	GOR44 large doors rounded 43 x 51 * standard
(B) ORTNER GOR44 automatic	GOR44RA	GOR44 large doors rounded 43 x 51 * standard

STEP 1.1: ALTERNATIVE DOOR CHOICE

NEW

ARTICLE	ARTICLE NR.	SPECIFICATION
(C) Additional function: self closing and/or self	OR-APTÜR	Self closing and/or self locking doors

STEP 1.1: CHOOSING GLASS

ARTICLE	ARTICLE NR.	SPECIFICATION
✓ (D) Black points, with full frame	OR-GTO-APG2	for large, straight doors
✓ (E) White points, with full frame	OR-GTO-APG5	for large, straight doors
✓ (E) White points, with full frame	OR-GTO-APR5	for large, rounded doors

STEP 2: CHOOSING BEZEL

ARTICLE	ARTICLE NR.	SPECIFICATION
✓ (F) Steel bezel straight	OR-SBG	for large, straight doors
(G) Steel bezel wide	OR-SBGR	for large doors, wide bezel
✓ (H) Steel bezel rounded	OR-SBG6	ø 600 mm, for large doors, rounded
(I) Steel bezel rounded, wide	OR-SBG6R	ø 600 mm, for large doors, wide bezel
✓ (J) Steel bezel rounded	OR-SBG7	ø 700 mm, for large doors
✓ (K) Steel bezel rounded	OR-SBG10	ø 1000 mm, for large doors

STEP 3: CHOOSING THE CONTROL METHOD

ARTICLE	ARTICLE NR.	SPECIFICATION
(L) Stove control LED	OR-STL	Combustion control with LED monitor
(M) Stove control Bluetooth (APP)	OR-STB	Combustion control with LED monitor and data transmission module (APP)

* Standard features: glass with a black full-framing and a handle: „silver cone“, excl. bezel.

** The Bluetooth control APP is available at www.ortner-cc.at or at your APP store.

✓ = available while stocks last

ORTNER GOR44

STEP 4: CHOOSING EXTERNAL AIRFLOW

ARTICLE	ARTICLE NR.	SPECIFICATION	SPEZIFIKATION
Automatic control	(N) Airflow I LED/APP	OR-LRA1-LB	Automatic airflow control consists of combustion air flap with actuator ø 125, with flexible aluminum pipe, hose clip (2 pcs.); air grid
Automatic control	(O) Airflow II LED/APP	OR-LRA2-LB	Automatic airflow control with combustion air box and actuator ø 125
Manual control	(P) External airflow I	OR-LRH1	Outside size 14,5 x 32,5 cm, RO manual airflow control consists of rectangular air box, air grid, flexible aluminum pipe, hose clip (2 pcs.)
Manual control	(Q) External airflow II	OR-LRH2	Outside size 23 x 23 cm, RO manual airflow control consists of rectangular air box, air grid, flexible aluminum pipe, hose clip (2 pcs.)

STEP 4.1: ACCESSORIES SET

ARTICLE	ARTICLE NR.	SPECIFICATION
(R) Accessories set ø 600	OR-BSET	Page 37
(R) Accessories set ø 700	OR-BSET70	Page 37

STEP 5: CHOOSING FLEX-SPEICHER SYSTEM

ARTICLE	SPECIFICATION
(S) Variant 1	Accumulation modules (Page 39)
(T) Variant 2	Cover KMS ø 180 KMS 300, ø 160 KWS 240 (Page 39)

COMBUSTION CHAMBER	AMOUNT SINGL KAM MODULES	AMOUNT DOUBLE KAM			OPENINGS		HEIGHT AT THE OPENING ø 200
		ø 120	ø 180	ø 200	ø 180	ø 200	
GOR44	5	x	x	x	x	800	
GOR44	6	x	x	x	x	900	
GOR44	7	x	x	x	x	1000	



The numbers show the min. or max. amount of accumulation modules*) The accumulation modules height when using the side opening ø200.

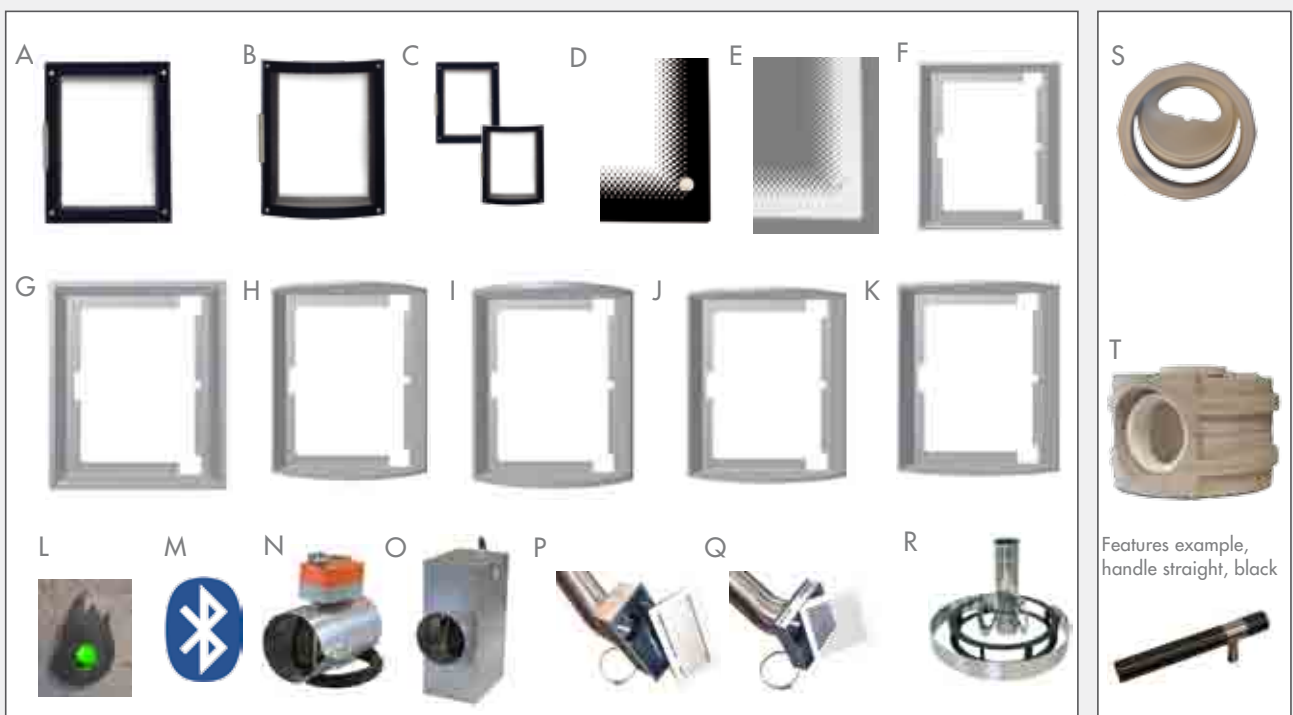

ORTNER COMBUSTION CHAMBER GO8T



The ORTNER Grundofen convinces with the easy mounting, fast montage at the customer and the various connection possibilities thanks to the system stones, which makes it possible for the oven-setter to create individual solution. The special combustion chamber form, combustion chamber cover as well as the organization of the airflow, guarantee clean combustion.

CHANGEABLE COMBUSTION CHAMBER PARTS

GO8T	KMS 240	KMS 300
Amount of wood	5 kg	5 kg
Accumulated heat	16 kWh	16 kWh
Heating efficiency/h with KMS-System for 8 hour refilling interval	-	2 kW
Heating efficiency/h with KMS-System for 6 hour refilling interval	2,7 kW	-
Weight of the firebox	227 kg	227 kg
Efficiency	84,1 %	84,1 %
Air supply regulation	man. od. autom.	man. od. autom.

STEP 1: CHOOSING COMBUSTION CHAMBER INCL. DOORS

ARTICLE	ARTICLE NR.	SPECIFICATION
(A) ORTNER Grundofen 8T	GO8T-GTA	automatic control, straight doors (43x51 cm) * standard
(A) ORTNER Grundofen 8T	GO8T-GTH	manual control, straight doors (43 x 51 cm) * standard
(B) ORTNER Grundofen 8T	GO8T-GRTA	automatic control, large, rounded doors (43 x 51 cm) * standard
(B) ORTNER Grundofen 8T	GO8T-GRTH	manual control, large, rounded doors (43 x 51 cm) * standard
(A+B) ORTNER Grundofen 8T	GO8T-GRGTA	automatic control, large rounded and straight doors (43 x 51 cm) * standard
(A+B) ORTNER Grundofen 8T	GO8T-GRGTH	manual control, large rounded and straight doors (43 x 51 cm) * standard

STEP 1.1: ALTERNATIVE DOOR CHOICE

NEW	ARTICLE	ARTICLE NR.	SPECIFICATION
	(C) Additional function: self closing and/or self	OR-APTÜR	Self closing and/or self locking doors

STEP 1.1: CHOOSING GLASS

ARTICLE	ARTICLE NR.	SPECIFICATION
✓ (D) Black points with full frame	OR-GTO-APG2	for large, straight doors
✓ (E) White points with full frame	OR-GTO-APG5	for large, straight doors
✓ (E) White points with full frame	OR-GTO-APR5	for large, rounded doors

STEP 2: CHOOSING BEZEL

ARTICLE	ARTICLE NR.	SPECIFICATION
✓ (F) Steel bezel straight	OR-SBG	for large, straight doors
(G) Steel bezel wide	OR-SBGR	for large doors, wide bezel
✓ (H) Steel bezel rounded	OR-SBG7	ø 700 mm, for large doors

STEP 3: CHOOSING THE CONTROL METHOD

ARTICLE	ARTICLE NR.	SPECIFICATION
(I) Stove control LED	OR-STL	Combustion control with LED monitor
(J) Stove control Bluetooth (APP)	OR-STB	Combustion control with LED monitor and data transmission module (APP)

* Standard features: glass with a black full-framing and a handle: „silver cone“, excl. bezel.

** The Bluetooth control APP is available at www.ortner-cc.at or at your APP store.

✓ = available while stocks last

ORTNER COMBUSTION CHAMBER GO8T

STEP 4: CHOOSING EXTERNAL AIRFLOW

ARTICLE	ARTICLE NR.	SPECIFICATION	SPEZIFIKATION
Automatic control	(K) Airflow I LED/APP	OR-LRA1-LB	Automatic airflow control consists of combustion air flap with actuator ø 125, with flexible aluminum pipe, hose clip (2 pcs.); air grid
Automatic control	(L) Airflow II LED/APP	OR-LRA2-LB	Automatic airflow control with combustion air box and actuator ø 125
Manual control	(M) External airflow I	OR-LRH1	Outside size 14,5 x 32,5 cm, RO manual airflow control consists of rectangular air box, air grid, flexible aluminum pipe, hose clip (2 pcs.)
Manual control	(N) External airflow II	OR-LRH2	Outside size 23 x 23 cm, RO manual airflow control consists of rectangular air box, air grid, flexible aluminum pipe, hose clip (2 pcs.)

STEP 5: CHOOSING FLEX-SPEICHER SYSTEM

ARTICLE	SPECIFICATION
(O) Variants	Accumulation sets z KMS 240 and KMS 300 (p. 40+42)

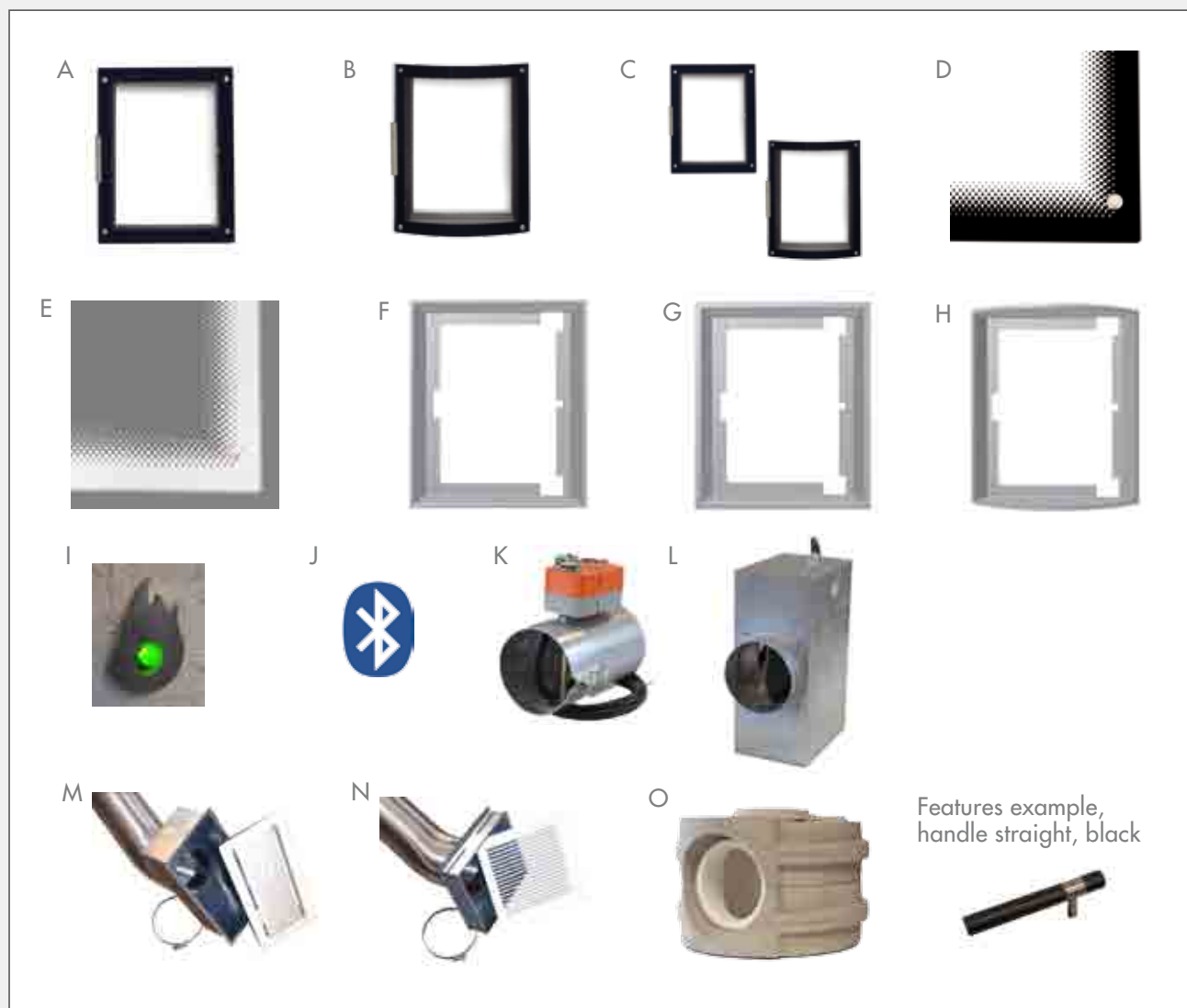

ORTNER COMBUSTION CHAMBER GO8



The ORTNER Grundofen convinces with the easy mounting, fast montage at the customer and the various connection possibilities thanks to the system stones, which makes it possible for the oven-setter to create individual solution. , combustion chamber cover as well as the organization of the airflow, guarantee clean combustion.
CHANGEABLE COMBUSTION CHAMBER PARTS

GO8	KMS 240	KMS 300
Amount of wood	8 kg	8 kg
Accumulated heat	25,6 kWh	25,6 kWh
Heating efficiency/h with KMS-System for 8 hour refilling interval	-	2,13 kW
Heating efficiency/h with KMS-System for 6 hour refilling interval	3,2 kW	-
Weight of the firebox	222 kg	222 kg
Efficiency	88,1 %	88,1 %
Air supply regulation	man. od. autom.	man. od. autom.

STEP 1: CHOOSING COMBUSTION CHAMBER INCL. DOORS

ARTICLE	ARTICLE NR.	SPECIFICATION
(A) ORTNER GO8	GO8-GTA	automatic control, straight doors (43x51 cm) * standard
(A) ORTNER GO8	GO8-GTH	manual control, straight doors (43 x 51 cm) * standard
(B) ORTNER GO8	GO8-GRTA	automatic control, large, rounded doors (43 x 51 cm) * standard
(B) ORTNER GO8	GO8-GRTH	manual control, large, rounded doors (43 x 51 cm) * standard

STEP 1.1: ALTERNATIVE DOOR CHOICE

NEW

ARTICLE	ARTICLE NR.	SPECIFICATION
(C) Additional function: self closing and/or self	OR-APTÜR	Self closing and/or self locking doors

STEP 1.1: CHOOSING GLASS

ARTICLE	ARTICLE NR.	SPECIFICATION
✓ (D) Black points with full frame	OR-GTO-APG2	for large, straight doors
✓ (E) White points with full frame	OR-GTO-APG5	for large, straight doors
✓ (E) White points with full frame	OR-GTO-APR5	for large, rounded doors

STEP 2: CHOOSING BEZEL

ARTICLE	ARTICLE NR.	SPECIFICATION
✓ (F) Steel bezel straight	OR-SBG	for large, straight doors
(G) Steel bezel wide	OR-SBGR	for large doors, wide bezel
✓ (H) Steel bezel rounded	OR-SBG7	ø 700 mm, for large doors

STEP 3: CHOOSING THE CONTROL METHOD

ARTICLE	ARTICLE NR.	SPECIFICATION
(I) Stove control LED	OR-STL	Combustion control with LED monitor
(J) Stove control Bluetooth (APP)	OR-STB	Combustion control with LED monitor and data transmission module (APP)

* Standard features: glass with a black full-framing and a handle: „silver cone“, excl. bezel.

** The Bluetooth control APP is available at www.ortner-cc.at or at your APP store.

✓ = available while stocks last

ORTNER COMBUSTION CHAMBER GO8

STEP 4: CHOOSING EXTERNAL AIRFLOW

ARTICLE	ARTICLE NR.	SPECIFICATION
Automatic control	(K) Airflow I LED/APP OR-LRA1-LB	Automatic airflow control consists of combustion air flap with actuator ø 125, with flexible aluminum pipe, hose clip (2 pcs.); air grid
Automatic control	(L) Airflow II LED/APP OR-LRA2-LB	Automatic airflow control with combustion air box and actuator ø 125
Manual control	(M) External airflow I OR-LRH1	Outside size 14,5 x 32,5 cm, RO manual airflow control consists of rectangular air box, air grid, flexible aluminum pipe, hose clip (2 pcs.)
Manual control	(N) External airflow II OR-LRH2	Outside size 23 x 23 cm, RO manual airflow control consists of rectangular air box, air grid, flexible aluminum pipe, hose clip (2 pcs.)

STEP 5: CHOOSING THE KMS CERAMIC ACCUMULATION MODULE

ARTICLE	SPECIFICATION
(O) Varianten	Accumulation sets with KMS 240 and KMS 300 (p. 40+42)

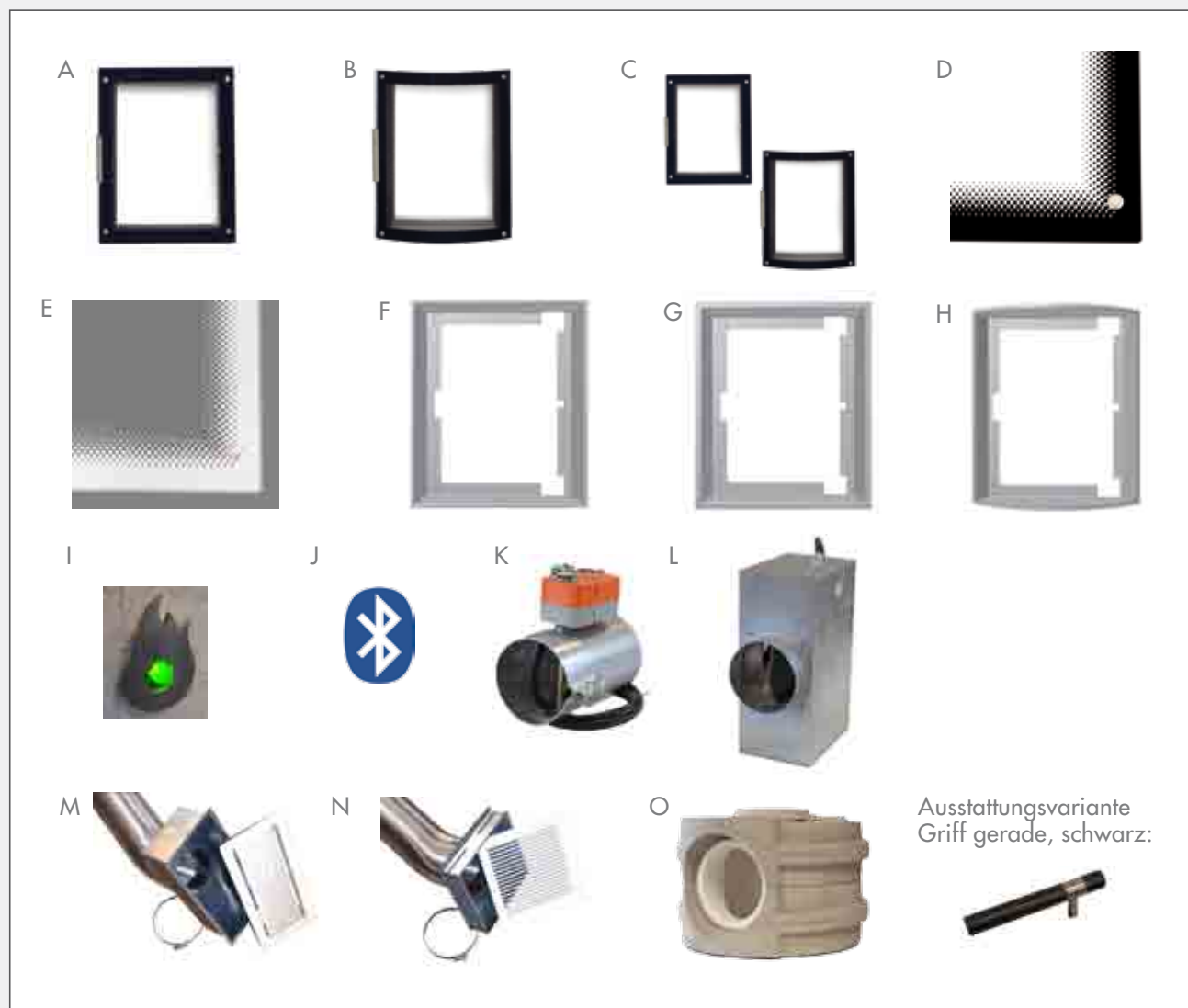

ORTNER COMBUSTION CHAMBER GO15



The ORTNER Grundofen convinces with the easy mounting, fast montage at the customer and the various connection possibilities thanks to the system stones, which makes it possible for the oven-setter to create individual solution. The special combustion chamber form, combustion chamber cover as well as the organization of the airflow, guarantee clean combustion.

CHANGEABLE COMBUSTION CHAMBER PARTS

GO8T	KMS 300	KMS 300
Amount of wood	15 kg	15 kg
Accumulated heat	48 kWh	48 kWh
Heating efficiency/h with KMS-System for 12 hour refilling interval	-	4 kW
Heating efficiency/h with KMS-System for 8 hour refilling interval	6 kW	-
Weight of the firebox	450 kg	450 kg
Efficiency	92,1 %	92,1 %
Air supply regulation	autom.	autom.

STEP 1: CHOOSING COMBUSTION CHAMBER INCL. DOORS

ARTICLE	ARTICLE NR.	SPECIFICATION
(A) ORTNER Grundofen	GO15-GT	automatic control, straight doors (43x51 cm) * standard
(B) ORTNER Grundofen	GO15-RT	automatic control, rounded doors (43 x 51 cm) * standard

STEP 1.1: ALTERNATIVE DOOR CHOICE

NEW

ARTICLE	ARTICLE NR.	SPECIFICATION
(C) Additional function: self closing and/or self	OR-APTÜR	Self closing and/or self locking doors

STEP 1.1: CHOOSING GLASS

ARTICLE	ARTICLE NR.	SPECIFICATION
V (D) Black points with full frame	OR-GTO-APG2	for large, straight doors
V (E) White points with full frame	OR-GTO-APG5	for large, straight doors
V (E) White points with full frame	OR-GTO-APR5	for large, rounded doors

STEP 2: CHOOSING BEZEL

ARTICLE	ARTICLE NR.	SPECIFICATION
V (F) Steel bezel straight	OR-SBG-10	(E) Steel bezel straight
(G) Steel bezel wide	OR-SBG	(F) Steel bezel wide
V (H) Steel bezel rounded	OR-SBGR	(G) Steel bezel rounded

STEP 3: CHOOSING THE CONTROL METHOD

ARTICLE	ARTICLE NR.	SPECIFICATION
(I) Stove control Bluetooth (APP)	OR-STB	Combustion control with LED monitor and data transmission module (APP)
(J) Ofensteuerung mit Bluetooth (APP)	OR-STB	Abbrandsteuerung mit LED und Datenübertragungsmodul (APP)**

* Standard features: glass with a black full-framing and a handle: „silver cone“, excl. bezel.

** The Bluetooth control APP is available at www.ortner-cc.at or at your APP store.

V = available while stocks last

ORTNER COMBUSTION CHAMBER GO15

STEP 4: CHOOSING EXTERNAL AIRFLOW

ARTICLE	ARTICLE NR.	SPECIFICATION	SPEZIFIKATION
Automatic control	(K) Airflow LED/APP	OR-LGA1-LB	Automatic airflow control GO consists of combustion air box with actuator , 2 x ø 100 connectors, 2 x flexible aluminum pipe plus hose clip (4 pc.); air grid

STEP 5: CHOOSING THE KMS CERAMIC ACCUMULATION MODULE

ARTICLE	SPECIFICATION
Accumulation Flex system	Page 39

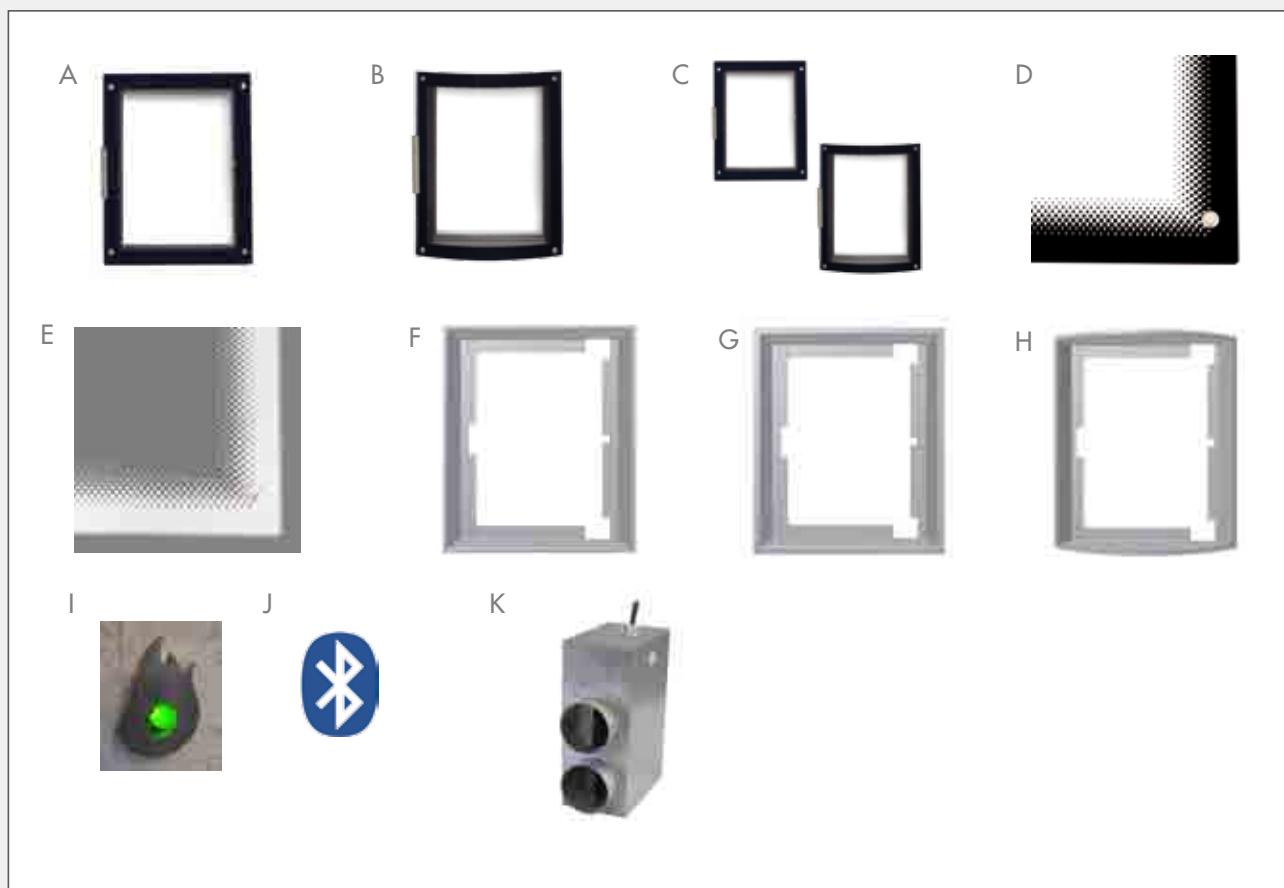

COMBUSTION CHAMBER VERSIONS

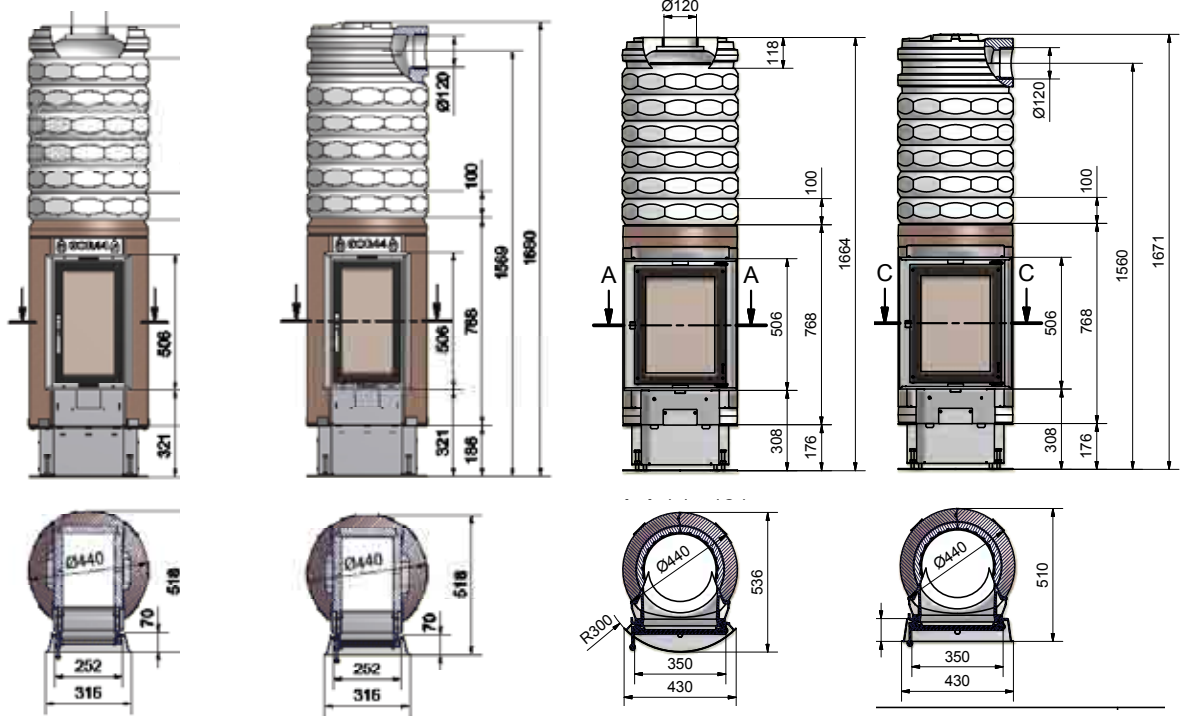

GOR44
Small doors

GOR44
Large doors

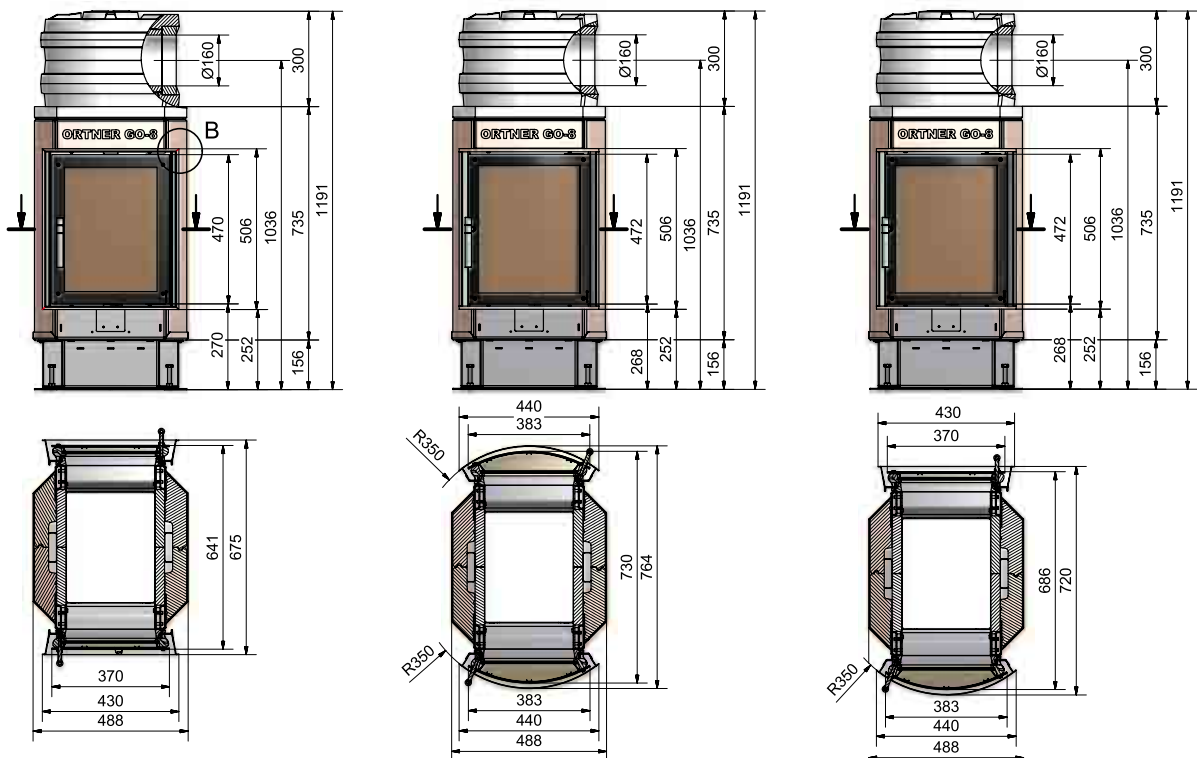

GO8T
2x straight doors
2x straight bezel

GO8T
2x rounded doors
2x rounded bezel

GO8T
1x straight doors, 1x rounded doors
1x straight bezel, 1x rounded bezel

COMBUSTION CHAMBER VERSIONS

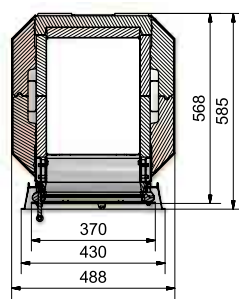
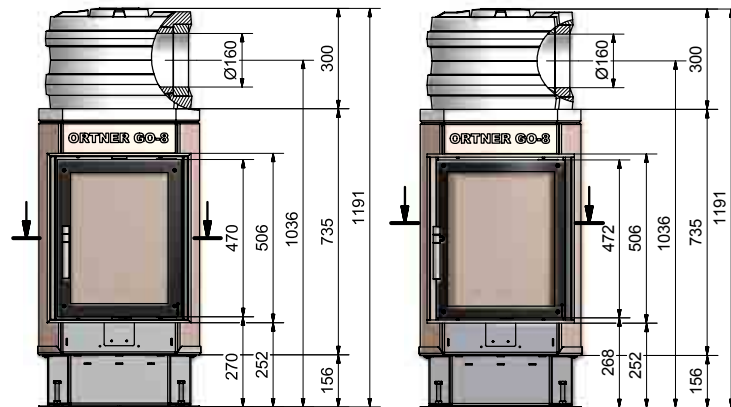

GO8
straight doors
straight bezel

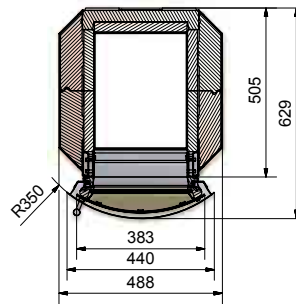

GO8
rounded doors
rounded bezel

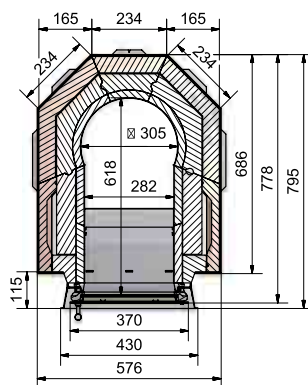
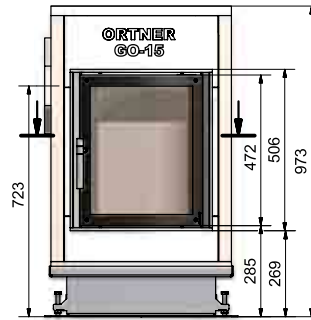
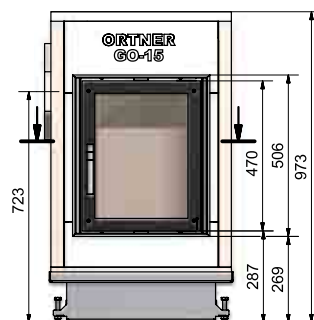

GO15
straight doors
straight bezel

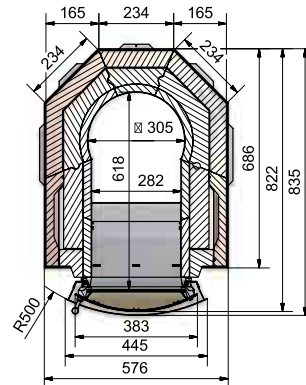

GO15
rounded doors
rounded bezel

ORTNER-SETS

SET GOR44, SMALL DOOR

TIP

PRODUKTBEZEICHNUNG	ARTIKEL NR.	SPEZIFIKATION
ORTNER Set GOR44	GOR-SETKAO	Automatic, GOR44 with small doors + 6 KAM + Accumulation cover with a top opening, Ø 120 – excl. bezel
ORTNER Set GOR44	GOR-SETKAS	Automatic, GOR44 with small doors + 5 KAM + Accumulation cover with a side opening, Ø 120 – excl. bezel
ORTNER Set GOR44	GOR-SETKHO	Manual, GOR44 with small doors + 6 KAM + Accumulation cover with a top opening, Ø 120 – excl. bezel
ORTNER Set GOR44	GOR-SETKHS	Manual, GOR44 with small doors + 5 KAM + Accumulation cover with a side opening, Ø 120 – excl. bezel



SET GOR44 BIG, STRAIGHT DOOR

TIP

PRODUKTBEZEICHNUNG	ARTIKEL NR.	SPEZIFIKATION
ORTNER Set GOR44	GOR-SETGAO	Automatic, GOR44 with big, straight doors + 6 KAM + Accumulation cover with a top opening, Ø 120 – excl. bezel
ORTNER Set GOR44	GOR-SETGAS	Automatic, GOR44 with big, straight doors + 5 KAM + Accumulation cover with a side opening, Ø 120 – excl. bezel
ORTNER Set GOR44	GOR-SETGHO	Manual, GOR44 with big, straight doors + 6 KAM + Accumulation cover with a side opening, Ø 120 – excl. bezel
ORTNER Set GOR44	GOR-SETGHS	Manual, GOR44 with big, straight doors + 5 KAM + Accumulation cover with a side opening, Ø 120 – excl. bezel



ORTNER-SETS

SET GOR44, BIG ROUND DOOR

TIP

PRODUKTBEZEICHNUNG	ARTIKEL NR.	SPEZIFIKATION
ORTNER Set GOR44	GOR-SETRAO	Automatic, GOR44 with big, round doors + 6 KAM + Accumulation cover with a top opening, Ø 120 – excl. bezel
ORTNER Set GOR44	GOR-SETRAS	Automatic, GOR44 with big, round doors + 5 KAM + Accumulation cover with a side opening, Ø 120 – excl. bezel
ORTNER Set GOR44	GOR-SETRHO	Manual, GOR44 with big, round doors + 6 KAM + Accumulation cover with a top opening, Ø 120 – excl. bezel
ORTNER Set GOR44	GOR-SETRHS	Manual, GOR44 with big, round doors + 5 KAM + Accumulation cover with a side opening, Ø 120 – excl. bezel



ACCESSORIES-SETS

ACCESSORIES SET Ø 600 / GOR44

Consists of:
frame for ceramic, bezel for base, wall rosette, ceramic stove rosette and pipe 50 cm

ARTICLE	ARTICLE NR.	SPECIFICATION
Accessories set Ø 600	OR-BSET	Frame for ceramic, height 10 cm, Ø 680, bezel for base, wall rosette, ceramic stove rosette and pipe 50 cm, Ø 120



ACCESSORIES SET Ø 700 / GOR44

Consists of:
frame for ceramic, bezel for base, wall rosette, ceramic stove rosette and pipe 50 cm

ARTICLE	ARTICLE NR.	SPECIFICATION
Accessories set Ø 700	OR-BSET70	Frame for ceramic, height 10 cm, Ø 680, bezel for base, wall rosette, ceramic stove rosette and pipe 50 cm, Ø 120



THE ORTNER KITCHEN STOVE

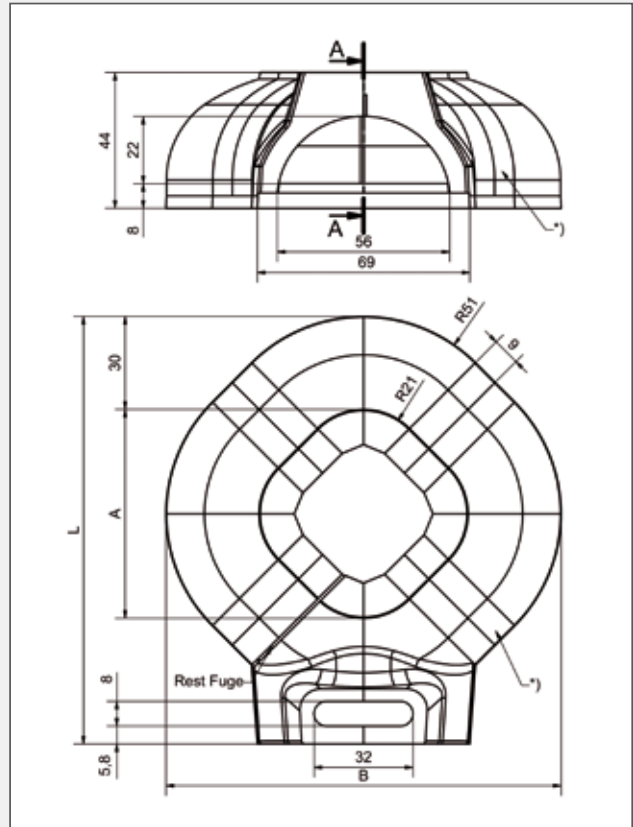

KITCHEN STOVE

ARTICLE	ARTICLE NR.	SPECIFICATION	WEIGHT
Kitchen stove model 1	OR-HO1	113,1 x 102,5 cm 62,3 dm ³	360 kg
Kitchen stove model 2	OR-HO2	125,8 x 115,2 cm 80,1 dm ³	433 kg
Kitchen stove model 3	OR-HO3	138,5 x 127,9 cm 98,7 dm ³	509 kg
Kitchen stove model 4	OR-HO4	151,2 x 140,6 cm 118,8 dm ³	591 kg

THE KITCHEN STOVE ACCESSORIES

ARTICLE	ARTICLE NR.	SPECIFICATION	WEIGHT
(A) Ashtray	OR-HZ3	Kitchen stove steel ashtray	7,0 kg
(B) Connection adapter	OR-HZ1	Kitchen stove connection adapter	10,0 kg
(C) Doors	OR-HZ2	Kitchen stove steel doors	7,5 kg
(D) Chimney cap	OR-HZ5	Kitchen stove chimney cap	3,5 kg
(E) Switch	OR4S-W101	Switch	0,5 kg

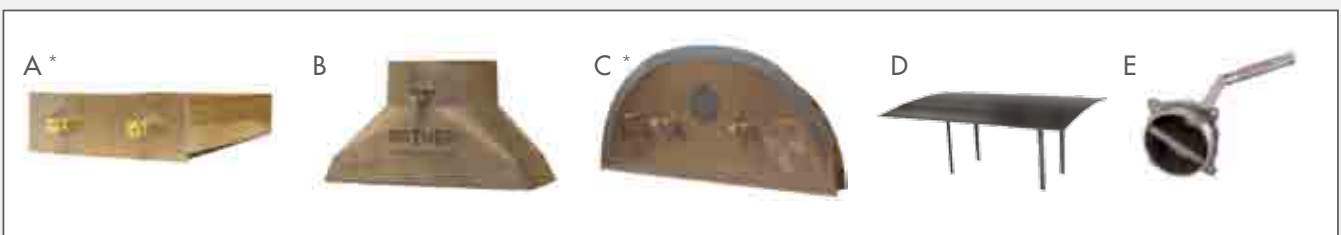

MOUNTABLE CERAMIC MODULES, KMS, CHIMNEY CONNECTING ELEMENTS, BIS

KAM MOUNTABLE CERAMIC MODULES

The ORTNER mountable ceramic modules allow prolongation of the heat releasing period! By using the ORTNER mountable accumulation modules this effect can be achieved easily, quickly and without gluing. Moreover, the mountable ceramic accumulation modules can be used in accumulation stoves of limited accumulation surface.

KAM

NEW

ARTICLE	ARTICLE NR.	SPECIFICATION	AMOUNT	WEIGHT
(A) KAM Accumulation disc up to 700°C	OR-S20	Ø 444 x 100 mm	1 pc.	25 kg
(B) KAM Two-piece accumulation disc up to 1000°C	OR-S50	Ø 444 x 100 mm	1 pc.	22 kg
(C) KAM Two-piece accumulation disc up to for automatic control 1000°C	OR-S50F	Ø 444 x 100 mm, disc with integrated thermal sensor incl. ceramic protective cover	1 pc.	22 kg

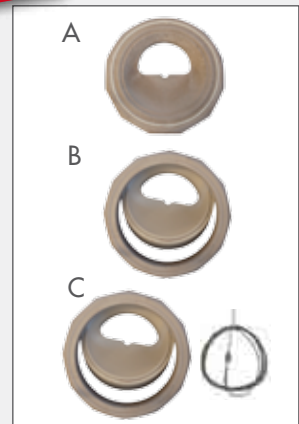

KAM Ø 444 FOR GOR44

ARTICLE	ARTICLE NR.	SPECIFICATION	AMOUNT	WEIGHT
(A) Accumulation cover with side opening, ø = 120 mm	OR-S30120	ø 444 x 200 mm, opening 120 mm, top and bottom part	1 Set = 2 pc.	1 pc. = 42 kg
(B) Accumulation cover with top opening, ø = 120 mm	OR-S20120	ø 444 x 100 mm	1 Stück	25 kg
(C) Accumulation cover with side opening, ø = 160 mm	OR-S30160	ø 444 x 200 mm, opening 160 mm, top and bottom part	1 Set = 2 pc.	1 pc. = 46 kg
(E) Accumulation cover with top opening, ø = 160 mm	OR-S20160	ø 444 x 100 mm, opening 160 mm	1 Stück	25 kg
(D) Accumulation cover with side opening, ø = 180 mm	OR-S30180	ø 444 x 200 mm, opening 180 mm	1 Set = 2 pc.	1 pc. = 47 kg
(E) Accumulation cover with top opening, ø = 180 mm	OR-S20180	ø 444 x 100 mm	1 pc.	25 kg
(F) Accumulation cover with side opening, ø = 200 mm	OR-S30200	ø 444 x 200 mm, opening 200 mm, top and bottom part	1 pc.	49 kg
(E) Accumulation cover with top opening, ø = 200 mm	OR-S20200	ø 444 x 100 mm, opening 200 mm	1 pc.	25 kg



ACCUMULATION COVERS KMS, FOR MODELS KMS 240, KMS 300, GO8, GO8T, GOR44

ARTICLE	ARTICLE NR.	SPECIFICATION	AMOUNT	WEIGHT
Accumulation connector cover	OR-KMS001000	(A) Accumulation cover ø 160 and (B) pipe HT ø 160 manual control	1 pc.	54 kg
Accumulation connector cover	OR-KMS002000	(A) Accumulation cover ø 160 and (B) pipe HT ø 160 automatic control*	1 pc.	54 kg
Accumulation connector cover	OR-KMS003000	(A) Accumulation cover ø 180 and (B) pipe HT ø 180 manual control	1 pc.	54 kg
Accumulation connector cover	OR-KMS004000	(A) Accumulation cover ø 180 and (B) pipe HT ø 180 automatic control*	1 pc.	54 kg



* incl. sensor

CERAMIC ACCUMULATION MODULE

KMS 300

CERAMIC ACCUMULATION MODULE

Chimney pipe system developed for the quality aware oven-setters – with unmatched heat conductivity and accumulation. Thanks to various connection possibilities and big choice of products, there is no limit to the designing possibilities. We have a special service for you – support in designing your KMS system.

Attention: for gluing and mounting the KMS module, use the Orfix 10 glue (p. 12)



ARTICLE	ARTICLE NR.	SPECIFICATION	WEIGHT
(A) KMS300 connector	OR45-R10	300 x 300 x 100 mm, Ø 180 mm	12,5 kg
(B) KMS300 pipe	OR45-R20	300 x 300 x 200 mm, Ø 180 mm	25 kg
(C) KMS300 bend 90°	OR45-K90	300 x 300 x 300 mm, Ø 180 mm	33 kg
(D) KMS300 bend 135°	OR45-K135	300 x 300 x 273 mm, Ø 180 mm	25 kg
(E) KMS300 T-piece, Ø 180 mm	OR450-T180	300 x 300 x 300 mm, ø180 mm, incl. ring	30 kg
(F) KMS300 with opening	OR45-R23	"	25 kg
(G) KMS300 bend 90°	OR45-K92	with side opening, 300 x 300 mm, ø 180 mm, incl. cleaning lid nr 2 and ring	33 kg
(H) KMS300 bend 90°	OR45-K93	with side opening, 300 x 300 mm, ø 180 mm, incl. cleaning lid nr 1 and ring	33 kg
(I) KMS300 cleaning lid 1	OR45-PD1	KMS 300 cleaning lid 1 top	1,6 kg
(J) KMS300 cleaning lid 2	OR45-PD2	KMS 300 cleaning lid 2 side	1,6 kg
(K) KMS300 frame and cleaning lid,	OR45-PG	KMS 300 T-piece	3 kg
(L) KMS300 pipe bypass	OR45-R22-30	with bypass 30 mm, 300 x 300 x 200 mm, ø 180 mm, incl. construction element, opening 30 mm	25 kg
(M) KMS300 pipe bypass	OR45-R22-40	with bypass 40 mm, 300 x 300 x 200 mm, ø 180 mm, incl. opening 30 mm	25 kg
(N) KMS300 2 pcs. bypass for KMS	OR45-Bypass-30	KMS 300 2 pcs. for pipes and bends, bypass 30 mm	2,5 kg
(O) KMS300 bend 90°	OR45-K94-30	with bypass 30 mm on top, 300 x 300 x 300 mm, ø 180 mm, incl. construction element and ring, opening 30 mm	33 kg
(P) KMS 300 bend 90°	OR45-K94-40	with bypass 40 mm on top, 300 x 300 x 300 mm, ø 180 mm, incl. construction element and ring, opening 40 mm	33 kg
(Q) KMS 300 2 pcs. bypass for KMS	OR45-Bypass-40	KMS 300 2 pc. for pipes and bends, bypass 40 mm	2,5 kg
(R) KMS 300 bend 90°	OR45-K95-30	with bypass 30 mm on side, 300 x 300 x 300 mm, ø 180 mm, incl. construction element and ring, opening 30 mm	33 kg

ARTICLE	ARTICLE NR.	SPECIFICATION	WEIGHT
(S) KMS 300 bend 90°	OR4S-K95-40	with bypass 40 mm on top, 300 x 300 x 300 mm, ø 180 mm, incl. construction element and ring, opening 40 mm	33 kg
(T) KMS 300 connector	OR4S-EA16	KMS 300 for steel pipes, ø 160 mm, 300 x 300 x 100 mm	10 kg
(U) KMS 300 connector	OR4S-EA7	KMS 300 for steel pipes, ø 180 mm, 300 x 300 x 70 mm	7,5 kg
(V) KMS 300 ring	OR4S-R	KMS 300 ring	0,5 kg
(W) KMS 300 concrete block	OR4S-AGS	KMS 300 concrete block, 200 x 100 x 100 mm	10 kg
(X) KMS 300 connector	OR4S-R11	KMS 300 connector with non return flap valve, 300 x 300 x 100 mm, ø 180 mm	13 kg
NEW (Y) KMS 300 flexible elbow	OR4S-W101	with switch	5 kg
(Z) KMS 300 accumulation filler	OR4S-S25	for filling up empty spaces within accumulation elements	sack = 25
NEW (AA) baffle 2 for KMS 300	OR4S-DS2	baffle 2 for KMS 300	1,4 kg
NEW (BA) baffle 5 for KMS 300	OR4S-DS5	baffle 5 for KMS 300	1,6 kg
NEW (CA) baffle 7 for KMS 300	OR4S-DS7	baffle 7 for KMS 300	1,9 kg
(DA) KMS bypass 300-240	OR4S-KA240	standing adapter 300-240 300 x 300 x 100, ø 180 – ø 160 mm	10 kg
(EA) temperature sensor	OR-TE4	thermal element 4lf with ceramic guard.	0,3 kg
! Orfix 10	OR9905-4	page 12	

REHEATING BOX KMS 300

REHEATING BOX

The ORTNER reheating box is made of KMS 300 Flexspeichersystem and uses convection as its functioning principle. Faster and simpler montage of an additional, ceramic heating element.
FOR CONSTRUCTIONS TO 16 kW

ARTICLE	ARTICLE NR.	SPECIFICATION	WEIGHT
KMS NHK 300	OR4S-NHK300	KMS-300 Reheating box set	Piece = 247,1 kg

**NEW**

ARTICLE	ARTICLE NR.	SPECIFICATION	WEIGHT
KMS NHK 300 with preheat path	OR4S-NHF-300	KMS-300 Reheating box set with preheat path	Piece = 333,4 kg

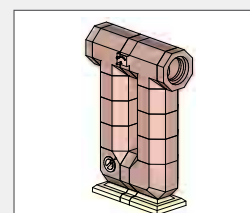

BIS 300 – FLOOR INSULATING STONES

FLOOR INSULATING STONES

They prevent the KMS systems to lose heat through the floors.

Attention: For gluing and joining the floor insulating stones use adhesive mortar (p. 4)

ARTICLE	ARTICLE NR.	SPECIFICATION	WEIGHT
(A) BIS 300 Vertical corner	OR-BIS-EH	300 x 300 x 80 mm	5,3 kg
(B) BIS 300 Horizontal corner	OR-BIS-EL	300 x 300 x 80 mm	5,3 kg
(C) BIS 300 Horizontal corner	OR-BIS-135	300 x 80 mm	3,5 kg
(D) BIS 300 Vertical element 10	OR-BIS-LH	300 x 100 x 80 mm	1,8 kg
(E) BIS 300 Vertical element 20	OR-BIS-L	300 x 200 x 80 mm	3,5 kg

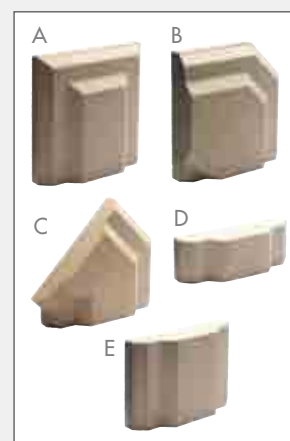

CERAMIC ACCUMULATION MODULE

KMS 240

CERAMIC ACCUMULATION MODULE

Chimney pipe system developed for the quality aware oven-setters – with unmatched heat conductivity and accumulation. Thanks to various connection possibilities and big choice of products, there is no limit to the designing possibilities. We have a special service for you – support in designing your KMS system.

Attention: for gluing and mounting the KMS module, use the Orfix 10 glue (p. 12)

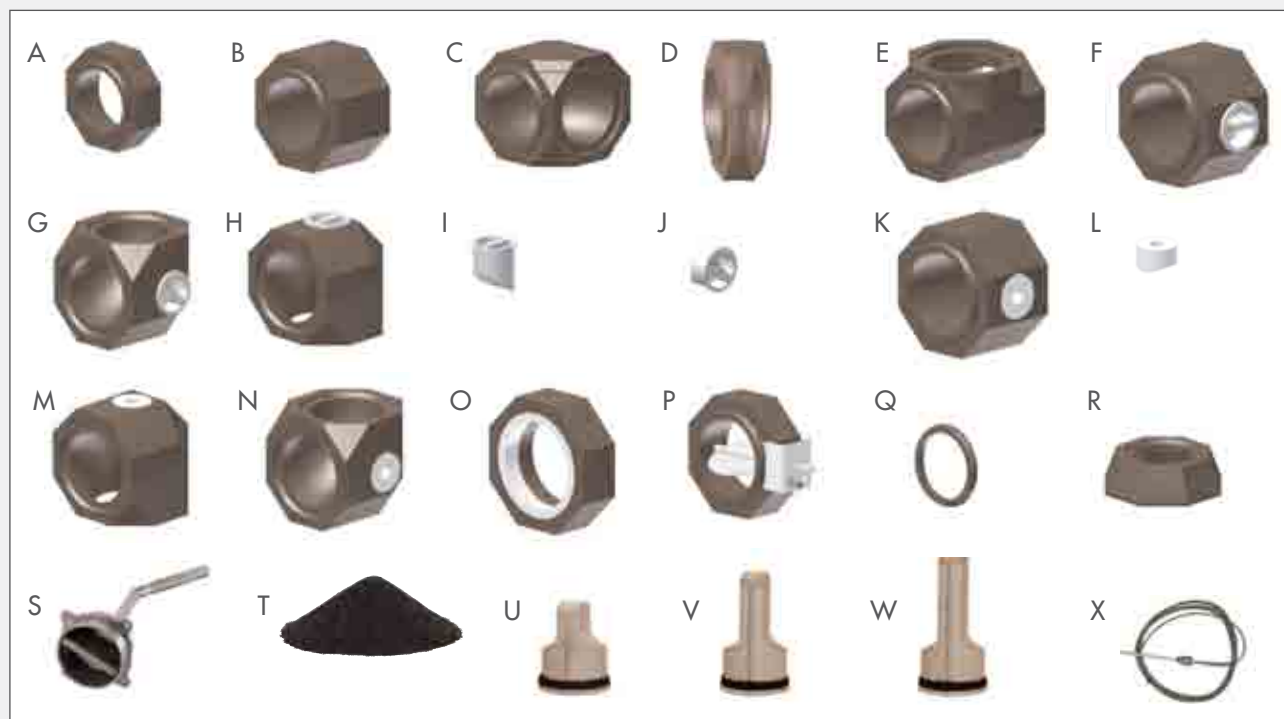

ARTICLE	ARTICLE NR.	SPECIFICATION	WEIGHT
(A) KMS 240 pipe	OR45-R08K	KMS 240 pipe 80 mm	6,0 kg
(B) KMS 240 pipe	OR45-R16K	KMS 240 pipe 160 mm	11,5 kg
(C) KMS 240 bend	OR45-K90K	KMS 240 bend 90°	17,5 kg
(D) KMS 240 bend	OR45-K225K	KMS 240 bend 22,5°	5,5 kg
(E) KMS 240 T-piece	OR45-T160K	KMS 240 T-piece	15,0 kg
(F) KMS 240 pipe	OR45-R16-PDK	KMS 240 pipe 160 mm with side clearing lid	11,5 kg
(G) KMS 240 bend 90°	OR45-K92K	KMS 240 bend 90° with side opening	17,5 kg
(H) KMS 240 bend 90°	OR45-K93K	KMS 240 bend 90° with top opening	17,5 kg
(I) KMS 240 cleaning lid	OR45-PD1K	KMS 240 cleaning lid 1 top	1,0 kg
(J) KMS 240 cleaning lid	OR45-PD2K	KMS 240 cleaning lid 2 side	1,0 kg
(K) KMS 240 pipe	OR45-R16-30K	KMS 240 pipe 160 mm with bypass ø 30 mm	11,5 kg
(L) KMS 240 bypass	OR45-BP-30K	KMS 240 pipe bypass and bends ø 30 mm	1,0 kg

ARTICLE	ARTICLE NR.	SPECIFICATION	WEIGHT
(M) KMS 240 bend with bypass	OR4S-K94-30K	KMS 240 bend 90° with top bypass 30 mm	17,5 kg
(N) KMS 240 bend bypass	OR4S-K95-30K	KMS 240 bend 90° with side bypass 30 mm	17,5 kg
(O) KMS 240 steel pipe connector	OR4S-EA16K	KMS 240 steel pipe connector	6,0 kg
NEW PRICE (P) KMS 240 pipe	OR4S-R08AK	KMS 240 connector with non return flap valve	7,0 kg
(Q) KMS 240 ring	OR4S-RK	KMS 240 ring for system pipes	0,5 kg
(R) Universal joint	OR4S-KA240	KMS universal joint with handle	10,0 kg
NEW (S) flexible elbow	OR4S-W101	with switch	1,0 kg
(T) Accumulation filler	OR4S-S25	Accumulation filler, heavy	25,0 kg
NEW (U) baffle 2 for KMS 240	OR4S-DS2K	baffle 2 for KMS 240	0,7 kg
NEW (V) baffle 5 for KMS 240	OR4S-DS5K	baffle 5 for KMS 240	0,9 kg
NEW (W) baffle 7 for KMS 240	OR4S-DS7K	baffle 7 for KMS 240	1,1 kg
(X) temperature sensor	OR-TE4	thermal element 4lf with ceramic guard.	0,3 kg
! Orfix 10	OR9905-4	page 12	

REHEATING BOX KMS 240

REHEATING BOX

The ORTNER reheating box is made of KMS 240 Flexspeichersystem and uses convection as its functioning principle. Faster and simpler montage of an additional, ceramic heating element. FOR CONSTRUCTIONS TO 8 kW

ARTICLE	ARTICLE NR.	SPECIFICATION	WEIGHT
KMS NHK 240	OR4S-NHK240	KMS-240 Reheating box set	117,5 kg



ARTICLE	ARTICLE NR.	SPECIFICATION	WEIGHT
KMS NHK 240 with preheat path	OR4S-NHF-240	KMS-240 Reheating box set with preheat path	178,2 kg

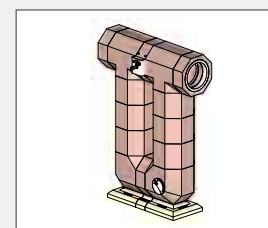

BIS 240 – FLOOR INSULATING STONES

FLOOR INSULATING STONES

They prevent the KMS systems to lose heat through the floors.

Attention: For gluing and joining the floor insulating stones use adhesive mortar (p. 4)

ARTICLE	ARTICLE NR.	SPECIFICATION	WEIGHT
(A) BIS 240 Vertical corner	OR-BIS-EHK	vertical, 240 x 240 x 65 mm	2,6 kg
(B) BIS 240 Horizontal corner	OR-BIS-225K	horizontal, 240 x 65 mm	1, kg
(C) BIS 240 Horizontal corner	OR-BIS-ELK	Corner 90° horizontal, 240 x 240 x 65	2,6 kg
(D) BIS 240 Vertical element 8 cm	OR-BIS-LHK	80 mm, 240 x 80 x 65 mm	1, kg
(E) BIS 240 Vertical element 16 cm	OR-BIS-LK	160 mm, 240 x 160 x 65 mm	2,0 kg

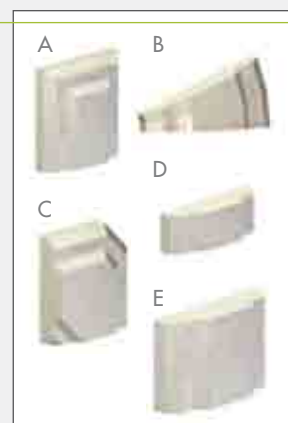

CHIMNEY CONNECTIONS

Vacuum formed and made of ceramic fibers elements for connecting smoke pipes to the chimney.

CHIMNEY CONNECTORS SQUARE

ARTICLE	ARTICLE NR.	SPECIFICATION	WEIGHT
Chimney connector square	OR21550	inside 150 x 150 mm – outside 280 x 280 mm	1 kg
Chimney connector square	OR21880	inside 180 x 180 mm – outside 280 x 280 mm	1 kg
Chimney connector square	OR21220	inside 200 x 200 mm – outside 330 x 330 mm	1 kg



CHIMNEY CONNECTORS ROUNDED 45°

ARTICLE	ARTICLE NR.	SPECIFICATION	WEIGHT
Chimney connector rounded 45°	OR21664	RR 160 x 45 x 160	1 kg
Chimney connector rounded 45°	OR21684	RR 160 x 45 x 180	1 kg
Chimney connector rounded 45°	OR21884	RR 180 x 45 x 180	1 kg
Chimney connector rounded 45°	OR21824	RR 180 x 45 x 200	1 kg
Chimney connector rounded 45°	OR21224	RR 200 x 45 x 200	1 kg
Chimney connector rounded 45°	OR21254	RR 200 x 45 x 250	1 kg
Chimney connector rounded 45°	OR21554	RR 250 x 45 x 250	1 kg



CHIMNEY CONNECTORS ROUNDED 90°

ARTICLE	ARTICLE NR.	SPECIFICATION	WEIGHT
Chimney connector rounded 90°	OR21009	RR 100 x 90 x 100	1 kg
Chimney connector rounded 90°	OR21119	RR 120 x 90 x 120	1 kg
Chimney connector rounded 90°	OR21669	RR 160 x 90 x 160	1 kg
Chimney connector rounded 90°	OR21689	RR 160 x 90 x 180	1 kg
Chimney connector rounded 90°	OR21889	RR 180 x 90 x 180	1 kg
Chimney connector rounded 90°	OR21829	RR 180 x 90 x 200	1 kg
Chimney connector rounded 90°	OR21229	RR 200 x 90 x 200	1 kg
Chimney connector rounded 90°	OR21259	RR 200 x 90 x 250	1 kg
Chimney connector rounded 90°	OR21559	RR 250 x 90 x 250	1 kg



INSULATING MATERIALS

THE ISOBOARD INSULATING BOARDS

ISOBOARD T-700

Lint and fiber free thermal insulation boards made of natural raw material vermiculite and binding agents. Used for insulating tiled stoves and fireplaces.

For use in areas permanently exposed to the temperatures up to 700 °C.

ARTICLE	ARTICLE NR.	SPECIFICATION	AMOUNT
Isoboard 500 mm	OR40230K	750 x 500 x 30 mm	box = 4 pc. / 1,5 m2
Isoboard 500 mm	OR40230	750 x 500 x 30 mm	palette = 60 pc. / 22,5 m2
Isoboard 1.000 mm	OR40231	750 x 1.000 x 30 mm	1 pc. = 0,75 m2
Isoboard 1.000 mm	OR40231	750 x 1.000 x 30 mm	palette = 30 pc. / 22,5 m2



ISOBOARD HD 1200

NEW

Fiber free thermal insulation boards made of natural material vermiculite and binding agent. Can be used as insulation in tiled-stove and chimney construction. Maximal allowable temperature is 1100 °C

ARTICLE	ARTICLE NR.	SPECIFICATION	AMOUNT
Isoboard HD 1200	OR40233	610x1000x30 1100°C	1Stk / 60 Stk



THE ISOBOARD INSULATING BOARDS GLUE

Quartzite-bound, fireproof glue resistant to temperatures up to 110 °C for joining highly absorbent surfaces, such as the ORTNER Isoboard insulation boards or other light construction materials.

ARTICLE	ARTICLE NR.	SPECIFICATION	AMOUNT
Isoboard glue	OR9903	Fireproof glue up to 1100 °C, paste	bucket = 3 kg
Isoboard glue	OR9903-1	Fireproof glue up to 1100 °C, thick liquid	plastic bag = 1 kg



STORE FROST PROTECTED!



STORE FROST PROTECTED!

SUPPLIES

OVEN-SETTER WIRE (GLOWED)

ARTICLE	ARTICLE NR.	SPECIFICATION	AMOUNT
Oven-setter wire	OR92010	in rods	1 set ca. 168 pcs. a 1,2 m = 201,6 m



CANTILEVER ARM

For floating seats and shelves, with adjustable height.

ARTICLE	ARTICLE NR.	SPECIFICATION	AMOUNT
Cantilever arm	OR90712	cantilever 400 mm, height 350-550mm	1 piece



FRESH AIR CABLE FLAP

For tiled-stoves with an external fresh air inflow.

ARTICLE	ARTICLE NR.	SPECIFICATION	AMOUNT
Cable Flap	OR90120	Cable flap 1600 mm, Ø 0 200 mm	1 piece
Cable flap, heat resistant up to 180°	OR90150	Cable flap 1600 mm, ø 150 mm	1 piece
Cable flap, heat resistant up to 180°	OR90200	Cable flap 1600 mm, ø 200 mm	1 piece



SMOKE PIPES



SMOKE PIPES, THICKNESS 2 MM, REDUCED

ARTICLE	ARTICLE NR.	SPECIFICATION	AMOUNT
Smoke pipe	H120-250	ø 120, reduced, 250 mm	1 piece
Smoke pipe	H120-500	ø 120, reduced, 500 mm	1 piece
Smoke pipe	H120-1000	ø 120, reduced, 1000 mm	1 piece
Smoke pipe	H160-250	ø 160, reduced, 250 mm	1 piece
Smoke pipe	H160-500	ø 160, reduced, 500 mm	1 piece
Smoke pipe	H160-1000	ø 160, reduced, 1000 mm	1 piece
Smoke pipe	H180-250	ø 180, reduced, 250 mm	1 piece
Smoke pipe	H180-500	ø 180, reduced, 500 mm	1 piece
Smoke pipe	H180-1000	ø 180, reduced, 1000 mm	1 piece
Smoke pipe	H200-250	ø 200, reduced, 250 mm	1 piece
Smoke pipe	H200-500	ø 200, reduced, 500 mm	1 piece
Smoke pipe	H200-1000	ø 200, reduced, 1000 mm	1 piece
Smoke pipe	H250-250	ø 250, reduced, 250 mm	1 piece
Smoke pipe	H250-500	ø 250, reduced, 500 mm	1 piece
Smoke pipe	H250-1000	ø 250, reduced, 1000 mm	1 piece

SMOKE PIPES

SMOKE PIPES - ELBOW, THICKNESS 2 MM, REDUCED

ARTICLE	ARTICLE NR.	SPECIFICATION	AMOUNT
Elbow	H120-45	ø 120, rotatable, reduced, 0- 45°	1 piece
Elbow	H120-90	ø 120, rotatable, reduced, 0-90°	1 piece
Elbow	H160-45	ø 160, rotatable, reduced, 0- 45°	1 piece
Elbow	H160-90	ø 160, rotatable, reduced, 0-90°	1 piece
Elbow	H180-45	ø 180, rotatable, reduced, 0- 45°	1 piece
Elbow	H180-90	ø 180, rotatable, reduced, 0-90°	1 piece
Elbow	H200-45	ø 200, rotatable, reduced, 0- 45°	1 piece
Elbow	H200-90	ø 200, rotatable, reduced, 0-90°	1 piece
Elbow	H250-45	ø 250, rotatable, reduced, 0- 45°	1 piece
Elbow	H 250-90	ø 250, rotatable, reduced, 0-90°	1 piece

SMOKE PIPES – MULTIPLE BENDS, THICKNESS 2 MM, REDUCED

TIP

ARTICLE	ARTICLE NR.	SPECIFICATION	AMOUNT
Multiple bend	H120-B4	ø 120, 4 elements, 450 mm	1 piece
Multiple bend	H160-B4	ø 160, 4 elements, 450 mm	1 piece
Multiple bend	H180-B4	ø 180, 4 elements, 450 mm	1 piece
Multiple bend	H200-B4	ø 200, 4 elements, 450 mm	1 piece
Multiple bend	H250-B4	ø 250, 4 elements, 450 mm	1 piece

SMOKE PIPES CLIP, THICKNESS 2 mm

ARTICLE	ARTICLE NR.	SPECIFICATION	AMOUNT
Smoke pipe clip	H120-DS	Ø 120	1 piece
Smoke pipe clip	H160-DS	Ø 160	1 piece
Smoke pipe clip	H180-DS	Ø 180	1 piece
Smoke pipe clip	H200-DS	Ø 200	1 piece
Smoke pipe clip	H250-DS	Ø 250	1 piece

SMOKE PIPES REDUCTION, THICKNESS 2 mm, EINGEZOGEN

ARTICLE	ARTICLE NR.	SPECIFICATION	AMOUNT
Smoke pipes reduction	H180-160RED	from ø 180 to ø 160, reduced	1 piece
Smoke pipes reduction	H200-180RED	from ø 200 to ø 180, reduced	1 piece

SMOKE PIPES T-PIECE, THICKNESS 2 mm, EINGEZOGEN

ARTICLE	ARTICLE NR.	SPECIFICATION	AMOUNT
Smoke pipe T-piece	H120-T	thickness 2mm, reduced, ø 120	1 piece
Smoke pipe T-piece	H160-T	thickness 2mm, reduced, ø 160	1 piece
Smoke pipe T-piece	H180-T	thickness 2mm, reduced, ø 180	1 piece
Smoke pipe T-piece	H200-T	thickness 2mm, reduced, ø 200	1 piece
Smoke pipe T-piece	H250-T	thickness 2mm, reduced, ø 250	1 piece

FLEXIBLE ALUMINUM PIPES, HEAT-RESISTANT PIPES

FLEXIBLE ALUMINUM PIPES, 1 LAYER, FOR SIMPLE INFLOW OF COLD AIR, MAX. LENGTH 3 M

ARTICLE	ARTICLE NR.	SPECIFICATION	AMOUNT
Flexible aluminum pipe	BE131-100	NW 100 mm	1 piece
Flexible aluminum pipe	BE131-125	NW 125 mm	1 piece
Flexible aluminum pipe	BE131-180	NW 180 mm	1 piece
Flexible aluminum pipe	BE131-200	NW 200 mm	1 piece

FLEXIBLE ALUMINUM PIPES, 2 LAYER, FOR SIMPLE INFLOW OF COLD AIR, AUF 3 m AUSZIEHBAR

ARTICLE	ARTICLE NR.	SPECIFICATION	AMOUNT
Flexible aluminum pipe	BE132-180	very durable, 2 layers, NW 180 mm, max. length 3 m	1 piece
Flexible aluminum pipe	BE132-200	very durable, 2 layers, NW 200 mm, max. length 3 m	1 piece

HOSE CLIP

ARTICLE	ARTICLE NR.	SPECIFICATION	AMOUNT
Hose clip	BE400-100	Hose clip ø90-110mm	1 piece
Hose clip	BE400-130	Hose clip ø120-140mm	1 piece
Hose clip	BE400-180	Hose clip ø170-190	1 piece
Hose clip	BE400-200	Hose clip ø190-210mm	1 piece

HEAT-RESISTANT SMOKE PIPE

ARTICLE	ARTICLE NR.	SPECIFICATION	AMOUNT
Heat-resistant smoke pipe	HT160-250	ø 160, length 250 mm	1 piece
Heat-resistant smoke pipe	HT180-250	ø 180, length 250 mm	1 piece
Heat-resistant smoke pipe	HT160-250A	for automatic control, ø 160 mm	1 piece
Heat-resistant smoke pipe	HT180-250A	for automatic control, ø 180 mm	1 piece
Heat-resistant smoke pipe	HTR180-160	from ø 180 mm to ø 160 mm	1 piece

THE ORTNER SPECIAL ARTICLES

CHIMNEY CAPS

ROTATING CHIMNEY CAP

Rotates when the wind blows. The cap is made of high quality stainless steel, rotatable steel axis, with double bearing for perfect rotation.

ARTICLE	ARTICLE NR.	SPECIFICATION	TEMPERATURE	AMOUNT
Rotating chimney cap	OR-AUFSATZ1-140	for chimney CNS ø 140	300 °C	1 piece
Rotating chimney cap	OR-AUFSATZ1-150	for chimney CNS ø 150	300 °C	1 piece
Rotating chimney cap	OR-AUFSATZ1-160	for chimney CNS ø 160	300 °C	1 piece
Rotating chimney cap	OR-AUFSATZ1-170	for chimney CNS ø 170	300 °C	1 piece
Rotating chimney cap	OR-AUFSATZ1-180	for chimney CNS ø 180	300 °C	1 piece
Rotating chimney cap	OR-AUFSATZ1-200	for chimney CNS ø 200	300 °C	1 piece
Rotating chimney cap	OR-AUFSATZ1-250	for chimney CNS ø 250	300 °C	1 piece
Rotating chimney cap	OR-AUFSATZ1-300	for chimney CNS ø 300	300 °C	1 piece



CHIMNEY CAP

Regulates the flue in case of too weak or too strong flue. It provides also a good protection against rain and snow. Bayonette catch enables an easy access to the chimney. Unusual sizes on order.

ARTICLE	ARTICLE NR.	SPECIFICATION	AMOUNT
✓ Chimney cap	OR-AUFSATZ2-160	for chimney CNS or with a mounting	1 piece
✓ Chimney cap	OR-AUFSATZ2-180	for chimney CNS or with a mounting	1 piece
✓ Chimney cap	OR-AUFSATZ2-200	for chimney CNS or with a mounting	1 piece
✓ Chimney cap	OR-AUFSATZ2-250	for chimney CNS or with a mounting	1 piece



SPECIAL ACCESSORIES

PLASTER BOARD

ARTICLE	ARTICLE NR.	SPECIFICATION	AMOUNT
Plaster board*	OR-PT	5 plaster boards (single pieces available on order)	5 piece



THE ORTNER IGNITER

ARTICLE	ARTICLE NR.	AMOUNT
(A) Igniter	OR-AN12	12 strips
(B) Igniter	OR-AN100	100 strips (box)



TOOL

CLEANING ACCESSOIRES FOR KAM NEW

ARTICLE	ARTICLE NR.	SPECIFICATION	AMOUNT
Cleaning accessories für KAM	OR-BUERSTE	Cleaning brush for KAM	1 = piece



ORTNER BEAK-SHAPED SPOUT NEW

ARTICLE	ARTICLE NR.	SPECIFICATION	AMOUNT
beak-shaped spout	OR900-6	beak-shaped spout for mixing liquid can	1 = piece



✓ = available while stocks last

FRESCO DESIGN TOOL SET

NEW

FRESCO Design Tool set with relevant tools and accessories.

ARTICLE	ARTICLE NR.	SPECIFICATION	AMOUNT
FRESCO tool set	OR-WZ001000	Consists of: ORTNER bucket; mason's pan; FRESCO-putty knife wide; putty knife narrow; finishing trowel plastic; finishing trowel serrated 4x4; smoother; roller set; structure creating rubber large; structure creating rubber small; structure creating sponge; sponge; block brush; sand paper; rubbing	1 = SET



FRESCO DESIGN TOOL

ARTICLE	ARTICLE NR.	SPECIFICATION	AMOUNT
(A) Toolbox	OR-Z1	Mobile work station FatMax 55x41x73	1 = piece
(B) ORTNER bucket	OR-KUE	ORTNER bucket with cover	20 liter
(C) Mason's cup	OR-PFANDL	Mason's cup galvanized	1 = piece
(D) FRESCO-Putty knife wide	OR-WZ001101	stainless 50 mm	1 = piece
(E) FRESCO-Putty knife narrow	OR-WZ001102	stainless 40 mm	1 = piece
(F) FRESCO Finishing trowel plastic	OR-WZ001103	Plastic 280x140 mm	1 = piece
(G) FRESCO Finishing trowel serrated 4x4	OR-WZ001104	stainless 280x140 mm 4mm serrated	1 = piece
(H) FRESCO-Smoother	OR-WZ001105	200x80 mm	1 = piece
(I) FRESCO Roller set	OR-WZ001106	2 rollers incl. grip + trough	1 = SET
(J) FRESCO Structure creating rubber large	OR-WZ001107	Width 150 mm	1 = piece
(K) FRESCO Structure creating rubber small	OR-WZ001108	Width 100 mm	1 = piece
(L) FRESCO Structure creating sponge	OR-WZ001109	Natural sponge ca. 140 mm	1 = piece
(M) FRESCO Sponge	OR-WZ001110	160 x 110 x 50 mm	1 = piece
(N) FRESCO Block brush oval	OR-WZ001111	Wooden grip 135x55 mm	1 = piece
(O) Sandpaper K360	OR-WZ001112	Grit = 360	1 = piece
(P) FRESCO Rubbing board	OR-WZ001113	280x140	1 = piece
(Q) FRESCO Rubbing board	OR-WZ001114	280x140	1 = piece
(R) FRESCO Rubbing board	OR-WZ001115	Styrofoam	1 = piece



TOOL

TOOLS OUTER SHELL

ARTICLE	ARTICLE NR.	SPECIFICATION	AMOUNT
Special drill	ORSB35	3,2 x 90 mm	1 pieces



ARTICLE	ARTICLE NR.	SPECIFICATION	AMOUNT
Carbide counterbore	OR92020	for ORTNER special drill 3,2 x 90 mm	1 pieces



ARTICLE	ARTICLE NR.	SPECIFICATION	AMOUNT
Screws TN55	OR90500	TN 55 mm	1 carton = 500 pcs.



ARTICLE	ARTICLE NR.	SPECIFICATION	AMOUNT
(A) Cast fireclay – crusher	BRE-51SET	cut length 51 cm, cut height 77 mm	55 kg
(B) Add-on kit	BRE-NACH	for table mounting	0,15 kg
(C) Spare wheels	BRE-RAD	Spare wheels for cast fireclay boards crusher	2 pieces



PRICE LIST 2012/13

„RECOMMENDED PRICE LIST“

valid from 01.07.2012 to 30.06.2013

ORTNER
KACHELOFEN MIT SYSTEM



all prices exclusive purchase tax, Changes and errors excluded.



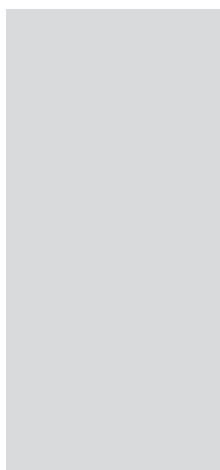

INDEX OF CONTENTS

MORTARS, ADHESIVES AND PLASTERS

Shell materials	Page 56
Construction materials; Special mortars	Page 56
Stove plasters	Page 56 - 57
Fresco	Page 57 - 58
Reinforcements	Page 58
Putties for tiled stoves	Seite 59 - 62
Paints for heated surfaces	Page 63
Elastic putty and silicone; Elastic putty and silicone	Page 63 - 65

READY STOVE-SETTING MATERIALS

Cast fireclay boards	Page 65 - 70
Stove boards	Page 70 - 71
Accumulation boards; Special construction elements; Special fireclay elements	Page 71 - 72
Universal boards, elbows and radii	Page 72 - 74

ORTNER COMBUSTION CHAMBERS AND SET

Combustion chamber GOR44	Page 74 - 77
Combustion chamber GO8T	Page 77 - 78
Combustion chamber GO8	Page 78 - 79
Combustion chamber GO15	Page 79 - 80
ORTNER stoves sets	Page 80 - 81
ORTNER kitchen stove	Page 82

MOUNTABLE CERAMIC MODULES, KMS, CHIMNEY CONNECTING ELEMENTS, BIS,

Mountable ceramic modules	Page 82 - 83
Ceramic accumulation module KMS 300 + BIS	Page 83 - 86
Ceramic accumulation module KMS 240 + BIS	Page 86 - 89
Chimney connections	Page 89 - 90

INSULATING MATERIALS

Isoboard, Isoboard HD	Page 90 - 91
-----------------------	--------------

PROCESSING

Supplies	Page 91
----------	---------

PIPES

Smoke pipes	Page 91 - 93
Flexible aluminum pipes, heat-resistant pipes	Page 93 - 94

THE ORTNER SPECIAL ARTICLES













Chimney caps	Page 94 - 95
Special accessories	Page 95
Tools	Page 95 - 97

TERMS AND CONDITIONS

Terms and Conditions	Page 99
----------------------	---------





NOTES

Index	Page 100 - 101
-------	----------------

PAGE	ARTICLE	ARTICLE NR.	SPECIFICATION	FEATURE	AMOUNT WEIGHT (KG)	PIECE / PALETTE	PRICE	PALETTE PRICE	
4	Adhesive mortar	OR110-20	Graining 0 – 2 mm		1 sack = 20 kg, 1 palette = 48 sacks	€ 60,20	€ 2.684,10		
4	Adhesive mortar Creme	OR110CR	Graining 0 – 1,2 mm		1 sack = 20 kg, 1 palette = 48 sacks	€ 65,70	€ 2.960,40		
4	Pressure-sensitive adhesive	OR115	Graining 0 – 1,2 mm		1 sack = 20 kg, 1 palette = 48 sackssacksSäcke	€ 34,10	€ 1.565,00		
5	Mortar	OR130-20	Fine graining (beige)		1 sack = 20 kg, 1 palette = 48 sacks	€ 17,40	€ 801,10		
5	HK mortar	OR160	Graining 0 – 1,2 mm, grey		1 sack = 20 kg, 1 palette = 48 sacks	€ 22,50	€ 1.025,20		
5	Cast fireclay mass	OR120	Graining 0 – 5 mm		1 sack = 25 kg, 1 palette = 42 sacks	€ 58,30	€ 2.404,90		
5	Refractory mortar	OR9934	Repair mortar; powder		1 can = 1 kg; 1 carton = 6 cans	€ 5,90	€ 35,70		
5	Repair mortar	OR9932-25	Graining medium = 0 – 4 mm		1 bucket = 2,5 kg + 1 bottle = 0,6 l	€ 38,80			
5	Repair mortar	OR9932	Graining medium = 0 – 4 mm		1 bucket = 5 kg + 1 bottle = 1,2 l	€ 76,50			
5	Refractory concrete 2200	OR-FB2200	powder 1200°C		bucket = 20 kg	€ 49,90			
6	Free-style structural plaster	OR151	Graining 0 – 0,5 mm		1 sack = 20 kg; 1 palette = 48 sacks	€ 25,60	€ 1.145,50		
6	Free-style structural plaster	OR150-20	Graining 0 – 1 mm		1 sack = 20 kg; 1 palette = 48 sacks	€ 25,60	€ 1.145,50		
6	Stove plaster	OR10-05-20	Graining 0 – 0,5 mm		1 sack = 20 kg; 1 palette = 48 sacks	€ 60,70	€ 2.769,00		





Colors marked with the letter „A“ must be tempered exclusively by means of the reducing agent.

* = special color only on order.

PAGE	ARTICLE	ARTICLE NR.	SPECIFICATION	FEATURE	AMOUNT WEIGHT (KG)	PIECE / PALETTE	PRICE	PALETTE PRICE	
6	Stove plaster	OR101-20	Graining 0 – 1 mm		1 sack = 20 kg; 1 palette = 48 sacks	€ 60,20	€ 2.745,90		
6	Adhesive mortar "Creme"	OR110CR	Graining 0 – 1,2 mm		1 sack = 20 kg; 1 palette = 48 sacks	€ 65,70	€ 2.960,40		
6	Bond and key coat	OR15	Graining 0 – 0,5 mm		1 sack = 20 kg; 1 palette = 48 sacks	€ 42,50	€ 1.944,80		
6	Adhesive plaster	OR100	Finest graining		1 sack = 25 kg; 1 palette = 42 sacks	€ 163,80	€ 6.671,10		
7	Fine-grained mortar	OR100-0110	Graining 0 – 0,02 mm		1 sack = 10 kg, 1 palette = 80 sacks	€ 44,80	€ 3.364,00		
7	Spackling paste FRESCO	OR100-01S	White		1 bucket = 2 kg	€ 16,20			
7	Spackling paste FRESCO	OR100-02	Black		1 bucket = 2 kg	€ 16,20			
7	Spackling paste FRESCO	OR100-03	Slate brown		1 bucket = 2 kg	€ 16,20			
7	Spackling paste FRESCO	OR100-04	Eggshell		1 bucket = 2 kg	€ 16,20			
7	Spackling paste FRESCO	OR100-05	Ivory		1 bucket = 2 kg	€ 16,20			
7	Spackling paste FRESCO	OR100-06	Inca gold (yellow 1)		1 bucket = 2 kg	€ 31,80			
7	Spackling paste FRESCO	OR100-07	Titanic (green 3)		1 bucket = 2 kg	€ 31,80			
7	Spackling paste FRESCO	OR100-08	Antique pink (red 2)		1 bucket = 2 kg	€ 16,20			
7	Spackling paste FRESCO	OR100-10	Lavender (blue 2)		1 bucket = 2 kg	€ 47,40			
7	Spackling paste FRESCO	OR100-11	Dark Brown		1 bucket = 2 kg	€ 16,20			
7	Spackling paste FRESCO	OR100-12	Shell (orange 1)		1 bucket = 2 kg	€ 16,20			
7	Spackling paste FRESCO	OR100-13	Sienna (red 1)		1 bucket = 2 kg	€ 16,20			
7	Spackling paste FRESCO	OR100-14	Green 8		1 bucket = 2 kg	€ 31,80			

V = available while stocks last

Colors marked with the letter „A“ must be tempered exclusively by means of the reducing agent.
* = special color only on order.

PAGE	ARTICLE	ARTICLE NR.	SPECIFICATION	FEATURE	AMOUNT WEIGHT (KG)	PIECE / PALETTE	PRICE	PALETTE PRICE
7	Spackling paste FRESCO	OR100-15	Blue 4		1 bucket = 2 kg		€ 31,80	
7	Spackling paste FRESCO	OR100-17	Red 4		1 bucket = 2 kg		€ 16,20	
7	Spackling paste FRESCO	OR100-18	Yellow 2		1 bucket = 2 kg		€ 16,20	
7	Spackling paste FRESCO	OR100-19	Orange 2		1 bucket = 2 kg		€ 16,20	
7	Spackling paste FRESCO	OR100-20	Blue 1		1 bucket = 2 kg		€ 47,40	
7	Spackling paste FRESCO	OR100-21	Green 1		1 bucket = 2 kg		€ 16,20	
7	Spackling paste FRESCO	OR100-22	Green 6		1 bucket = 2 kg		€ 16,20	
7	Spackling paste FRESCO	OR100-23	Violet 1		1 bucket = 2 kg		€ 47,40	
7	Spackling paste FRESCO	OR100-24	Anthracite		1 bucket = 2 kg		€ 16,20	
7	Spackling paste FRESCO	OR100-25	Slate grey		1 bucket = 2 kg		€ 16,20	
7	Spackling paste FRESCO	OR100-26	Concrete Grey		1 bucket = 2 kg		€ 16,20	
7	Fresco Design basic kit	OR-SA002000	Consists of: 2 bags of smoothing plaster; 1 unit of reducing agent (5L); Fresco: white, black slate brown, slate grey, sienna and shell (a bucket each)		2 bags, 1 canister 6 buckets a 2 kg		€ 184,60	
7	Mixing liquid	OR900-5	1 canister		5 liters		€ 18,10	
7	Mixing liquid	OR900	1 canister		10 liters		€ 31,60	
8	Glass fiber grid	OR972	6 x 6 mm, tight, trick		1 reel = 50 m ² ; 5,5 kg		€ 219,80	
8	Fibreglass silk grid	OR973	very tight		1 reel = 20 m ² ; 1,5 kg		€ 131,10	
8	Textile wall-paper	OR960	thick		1 reel = 50 m ² ; 6 kg		€ 254,90	

PAGE	ARTICLE	ARTICLE NR.	SPECIFICATION	FEATURE	AMOUNT WEIGHT (KG)	PIECE / PALETTE	PRICE	PALETTE PRICE
9	Putty	OR5000-2	000 Black „A“		1 bucket = 2 kg		€ 18,10	
9	Putty	OR5097-2	097 Red black / Basalt „A“		1 bucket = 2 kg		€ 18,10	
9	Putty	OR5098-2	098 Blue black „A“		1 bucket = 2 kg		€ 18,10	
9	Putty	OR5100-2	100 White		1 bucket = 2 kg		€ 18,10	
9	Putty	OR5220-2	220 White grey		1 bucket = 2 kg		€ 18,10	
9	Putty	OR5240-2	240 Bright grey		1 bucket = 2 kg		€ 18,10	
9	Putty	OR5250-2	250 Slate grey „A“		1 bucket = 2 kg		€ 18,10	
9	Putty	OR5260-2	260 Dark grey „A“		1 bucket = 2 kg		€ 18,10	
9	Putty	OR5270-2	270 Cement grey „A“		1 bucket = 2 kg		€ 18,10	
9	Putty	OR5280-2	280 Anthracite „A“		1 bucket = 2 kg		€ 18,10	
9	Putty	OR5320-2	320 Egg-white / Birch		1 bucket = 2 kg		€ 18,10	
9	Putty	OR5340-2	340 Hazelnut „A“		1 bucket = 2 kg		€ 18,10	
9	Putty	OR5360-2	360 Dark brown „A“		1 bucket = 2 kg		€ 18,10	
9	Putty	OR5380-2	380 Dark ochre „A“		1 bucket = 2 kg		€ 18,10	
9	Putty	OR5420-2	420 Light blue *		1 bucket = 2 kg		€ 18,10	
9	Putty	OR5440-2	440 Blue „A“		1 bucket = 2 kg		€ 18,10	
9	Putty	OR5460-2	460 Dark blue „A“		1 bucket = 2 kg		€ 18,10	
9	Putty	OR5490-2	490 Rustic blue „A“		1 bucket = 2 kg		€ 18,10	
9	Putty	OR5560-2	560 Dark tur- quoise		1 bucket = 2 kg		€ 18,10	
9	Putty	OR5620-2	620 Light green		1 bucket = 2 kg		€ 18,10	
9	Putty	OR5630-2	630 Capri blue		1 bucket = 2 kg		€ 18,10	

Colors marked with the letter „A“ must be tempered exclusively by means of the reducing agent.
* = special color only on order.



PAGE	ARTICLE	ARTICLE NR.	SPECIFICATION	FEATURE	AMOUNT WEIGHT (KG)	PIECE / PALETTE	PRICE	PALETTE PRICE
9	Putty	OR5640-2	640 Moos green „A“		1 bucket = 2 kg		€ 18,10	
9	Putty	OR5660-2	660 Dark green „A“		1 bucket = 2 kg		€ 18,10	
9	Putty	OR5680-2	680 Ivy green „A“		1 bucket = 2 kg		€ 18,10	
9	Putty	OR5690-2	690 Rustic green „A“		1 bucket = 2 kg		€ 18,10	
9	Putty	OR5720-2	720 Light rusty „A“		1 bucket = 2 kg		€ 18,10	
9	Putty	OR5740-2	740 Rusty „A“		1 bucket = 2 kg		€ 18,10	
9	Putty	OR5760-2	760 Dark rusty „A“		1 bucket = 2 kg		€ 18,10	
9	Putty	OR5790-2	790 Red brow „A“		1 bucket = 2 kg		€ 18,10	
9	Putty	OR5850-2	850 Salmon		1 bucket = 2 kg		€ 18,10	
9	Putty	OR5910-2	910 Ivory		1 bucket = 2 kg		€ 18,10	
9	Putty	OR5920-2	920 Mohair (White beige)		1 bucket = 2 kg		€ 18,10	
9	Putty	OR5940-2	940 Light raspberry*		1 bucket = 2 kg		€ 18,10	
9	Putty	OR5960-2	960 Dark raspberry „A“*		1 bucket = 2 kg		€ 18,10	
9	Putty	OR5980-2	980 Dark red „A“		1 bucket = 2 kg		€ 18,10	
9	Putty	OR5000-4	000 Black „A“		1 bucket = 4,5 kg		€ 41,30	
9	Putty	OR5097-4	097 Red black / Basalt „A“		1 bucket = 4,5 kg		€ 41,30	
9	Putty	OR5098-4	098 Blue black „A“		1 bucket = 4,5 kg		€ 41,30	
9	Putty	OR5100-4	100 White		1 bucket = 4,5 kg		€ 41,30	
9	Putty	OR5220-4	220 White grey		1 bucket = 4,5 kg		€ 41,30	
9	Putty	OR5240-4	240 Bright grey		1 bucket = 4,5 kg		€ 41,30	
9	Putty	OR5250-4	250 Slate grey „A“		1 bucket = 4,5 kg		€ 41,30	

Colors marked with the letter „A“ must be tempered exclusively by means of the reducing agent.



* = special color only on order.

PAGE	ARTICLE	ARTICLE NR.	SPECIFICATION	FEATURE	AMOUNT WEIGHT (KG)	PIECE / PALETTE	PRICE	PALETTE PRICE
9	Putty	OR5260-4	260 Dark grey „A“		1 bucket = 4,5 kg		€ 41,30	
9	Putty	OR5270-4	270 Cement grey „A“		1 bucket = 4,5 kg		€ 41,30	
9	Putty	OR5280-4	280 Anthracite „A“		1 bucket = 4,5 kg		€ 41,30	
9	Putty	OR5320-4	320 Egg-white / Birch		1 bucket = 4,5 kg		€ 41,30	
9	Putty	OR5340-4	340 Hazelnut „A“		1 bucket = 4,5 kg		€ 41,30	
9	Putty	OR5360-4	360 Dark brown „A“		1 bucket = 4,5 kg		€ 41,30	
9	Putty	OR5380-4	380 Dark ochre „A“		1 bucket = 4,5 kg		€ 41,30	
9	Putty	OR5420-4	420 Light blue *		1 bucket = 4,5 kg		€ 41,30	
9	Putty	OR5440-4	440 Blue „A“		1 bucket = 4,5 kg		€ 41,30	
9	Putty	OR5460-4	460 Dark blue „A“		1 bucket = 4,5 kg		€ 41,30	
9	Putty	OR5490-4	490 Rustic blue „A“		1 bucket = 4,5 kg		€ 41,30	
9	Putty	OR5560-4	560 Dark tur- quoise		1 bucket = 4,5 kg		€ 41,30	
9	Putty	OR5620-4	620 Light green		1 bucket = 4,5 kg		€ 41,30	
9	Putty	OR5630-4	630 Capri blue		1 bucket = 4,5 kg		€ 41,30	
9	Putty	OR5640-4	640 Moos green „A“		1 bucket = 4,5 kg		€ 41,30	
9	Putty	OR5660-4	660 Dark green „A“		1 bucket = 4,5 kg		€ 41,30	
9	Putty	OR5680-4	680 Ivy green „A“		1 bucket = 4,5 kg		€ 41,30	
9	Putty	OR5690-4	690 Rustic green „A“		1 bucket = 4,5 kg		€ 41,30	
9	Putty	OR5720-4	720 Light rusty „A“		1 bucket = 4,5 kg		€ 41,30	
9	Putty	OR5740-4	740 Rusty „A“		1 bucket = 4,5 kg		€ 41,30	
9	Putty	OR5760-4	760 Dark rusty „A“		1 bucket = 4,5 kg		€ 41,30	













Colors marked with the letter „A“ must be tempered exclusively by means of the reducing agent.
* = special color only on order.









PAGE	ARTICLE	ARTICLE NR.	SPECIFICATION	FEATURE	AMOUNT WEIGHT (KG)	PIECE / PALETTE	PRICE	PALETTE PRICE
9	Putty	OR5790-4	790 Red brow „A“		1 bucket = 4,5 kg		€ 41,30	
9	Putty	OR5850-4	850 Salmon		1 bucket = 4,5 kg		€ 41,30	
9	Putty	OR5910-4	910 Ivory		1 bucket = 4,5 kg		€ 41,30	
9	Putty	OR5920-4	920 Mohair (White beige)		1 bucket = 4,5 kg		€ 41,30	
9	Putty	OR5940-4	940 Light raspberry*		1 bucket = 4,5 kg		€ 41,30	
9	Putty	OR5960-4	960 Dark raspberry „A“*		1 bucket = 4,5 kg		€ 41,30	
9	Putty	OR5980-4	980 Dark red „A“		1 bucket = 4,5 kg		€ 41,30	
9	Mixing liquid	OR900-5	1 canister		5 liters		€ 18,10	
9	Mixing liquid	OR900	1 canister		10 liters		€ 31,60	
10	Paint	OR6000	000 Black * „A“		1 bucket = 2kg		€ 32,80	
10	Paint	OR6097	097 Red black / Basalt* „A“		1 bucket = 2kg		€ 32,80	
10	Paint	OR6098	098 Blue black* „A“		1 bucket = 2kg		€ 32,80	
10	Paint	OR6100	100 White		1 bucket = 2kg		€ 32,80	
10	Paint	OR6220	220 White grey		1 bucket = 2kg		€ 32,80	
10	Paint	OR6240	240 Light grey		1 bucket = 2kg		€ 32,80	
10	Paint	OR6250	250 Slate grey „A“		1 bucket = 2kg		€ 32,80	
10	Paint	OR6260	260 Dark grey „A“		1 bucket = 2kg		€ 32,80	
10	Paint	OR6270	270 Cement grey „A“		1 bucket = 2kg		€ 32,80	
10	Paint	OR6280	280 Anthracite „A“		1 bucket = 2kg		€ 32,80	
10	Paint	OR6320	320 Egg-white / Birch*		1 bucket = 2kg		€ 32,80	
10	Paint	OR6340	340 Hazelnut „A“		1 bucket = 2kg		€ 32,80	
10	Paint	OR6360	360 Dark brown* „A“		1 bucket = 2kg		€ 32,80	

Colors marked with the letter „A“ must be tempered exclusively by means of the reducing agent.
* = special color only on order.

PAGE	ARTICLE	ARTICLE NR.	SPECIFICATION	FEATURE	AMOUNT WEIGHT (KG)	PIECE / PALETTE	PRICE	PALETTE PRICE
10	Paint	OR6380	380 Dark ochre* „A“		1 bucket = 2kg		€ 32,80	
10	Paint	OR6420	420 Light blue		1 bucket = 2kg		€ 32,80	
10	Paint	OR6440	440 Blue* „A“		1 bucket = 2kg		€ 32,80	
10	Paint	OR6460	460 Dark blue* „A“		1 bucket = 2kg		€ 32,80	
10	Paint	OR6490	490 Rustic blue „A“		1 bucket = 2kg		€ 32,80	
10	Paint	OR6560	560 Dark tur- quoise*		1 bucket = 2kg		€ 32,80	
10	Paint	OR6620	620 Light green		1 bucket = 2kg		€ 32,80	
10	Paint	OR6630	630 Capri blue*		1 bucket = 2kg		€ 32,80	
10	Paint	OR6640	640 Moos green* „A“		1 bucket = 2kg		€ 32,80	
10	Paint	OR6660	660 Dark green „A“		1 bucket = 2kg		€ 32,80	
10	Paint	OR6680	680 Ivy green*		1 bucket = 2kg		€ 32,80	
10	Paint	OR6690	690 Rustic green* „A“		1 bucket = 2kg		€ 32,80	
10	Paint	OR6720	720 Light rusty „A“		1 bucket = 2kg		€ 32,80	
10	Paint	OR6740	740 Rusty „A“		1 bucket = 2kg		€ 32,80	
10	Paint	OR6760	760 Dark rusty		1 bucket = 2kg		€ 32,80	
10	Paint	OR6790	790 Brown red* „A“		1 bucket = 2kg		€ 32,80	
10	Paint	OR6850	850 Salmon		1 bucket = 2kg		€ 32,80	
10	Paint	OR6910	910 Ivory		1 bucket = 2kg		€ 32,80	
10	Paint	OR6920	920 Mohair		1 bucket = 2kg		€ 32,80	
10	Paint	OR6940	940 Light raspberry*		1 bucket = 2kg		€ 32,80	
10	Paint	OR6960	960 Dark raspberry* „A“		1 bucket = 2kg		€ 32,80	
10	Paint	OR6980	980 Dark red „A“		1 bucket = 2kg		€ 32,80	
10	Mixing liquid	OR900-5	1 canister		5 liters		€ 18,10	
10	Mixing liquid	OR900	1 canister		10 liters		€ 31,60	

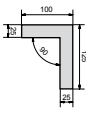
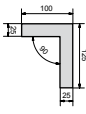
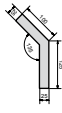
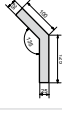

Colors marked with the letter „A“ must be tempered exclusively by means of the reducing agent.
* = special color only on order.

PAGE	ARTICLE	ARTICLE NR.	SPECIFICATION	FEATURE	AMOUNT WEIGHT (KG)	PIECE / PALETTE	PRICE	PALETTE PRICE
11	Elastic putty	OR9907-03	White		small can = 0,3 kg		€ 6,40	
11	Elastic putty	OR9907-10	White		medium can = 1,0 kg		€ 15,20	
11	Elastic putty	OR9907-20	White		bucket = 2,0 kg		€ 26,90	
11	Elastic putty	OR9907-K	White		cartridge = 0,40 kg		€ 12,60	
11	Elastic putty	OR9910-03	Black		small can = 0,3 kg		€ 6,40	
11	Elastic putty	OR9910-10	Black		medium can = 1,0 kg		€ 15,20	
11	Elastic putty	OR9910-20	Black		bucket = 2,0 kg		€ 26,90	
11	Elastic putty	OR9910-K	Black		cartridge = 0,40 kg		€ 12,60	
11	Silicone	OR9926	White, up to 250 °C		cartridge =310 ml		€ 21,90	
11	Silicone	OR9928	Gray, up to 250 °C		cartridge =310 ml		€ 21,90	
11	Silicone	OR9925	Black, up to 250 °C		cartridge =310 ml		€ 21,90	
11	Silicone	OR9927	Red, up to 250 °C		cartridge =310 ml		€ 21,90	
12	Orfix 10	OR9905-4	Black		1 bucket = 4 kg		€ 23,30	

PAGE	ARTICLE	ARTICLE NR.	SPECIFICATION	FEATURE	AMOUNT WEIGHT (KG)	PIECE / PALETTE	PRICE	PALETTE PRICE	
12	Orfix 10	OR9905-2	Black		1 sack = 20 kg		€ 100,80		
12	Orfix13S	OR9904	light pasty		1 bucket = 5 kg		€ 31,60		
12	Reduction liquid	OR110E	for adhesive mortar		400 ml		€ 1,70		
13	Cast fireclay board	OR700	standard size 500 x 1.200 x 25 mm		1 pc. = 33 kg, 1 palette = 25 pcs.		€ 65,60	€ 1.525,70	
13	Cast fireclay board	OR7000	standard size 500 x 1.000 x 25 mm		1 pc. = 28 kg; 1 palette = 25 pcs.		€ 55,80	€ 1.282,70	
13	Fireclay pilaster strip	OR772	96 x 1200 x 25 mm		1 pc. = 6,4 kg		€ 14,00	€ 1.560,00	
13	Fireclay pilaster strip	OR773	122 x 1200 x 25 mm		1 pc. = 8 kg		€ 17,10	€ 1.508,00	
13	Fireclay pilaster strip	OR774	163 cm x 1200 x 25 mm		1 pc. = 10,7 kg		€ 21,90	€ 1.456,00	
13	Fireclay elbow 90°	OR750	thickness 25 mm, 100x125x500 mm		1 pc. = 6,4 kg		€ 32,80		
13	Fireclay elbow 90°	OR750-1	thickness 25 mm, 100x125x1000 mm		1 pc. = 12,8 kg		€ 65,60		
13	Fireclay elbow 135°	OR760	thickness 25 mm, 100x125x500 mm		1 pc. = 6,4 kg		€ 32,80		
13	Fireclay elbow 135°	OR760-1	thickness 25 mm, 100x125x1000 mm		1 pc. = 12,8 kg		€ 65,60		
13	Fireclay pilaster strip 100/75/100	OR791	thickness 25 mm, height 500 mm, rounding angle 135°		1 pc. = 6,83 kg		€ 36,30		





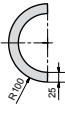





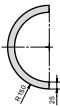
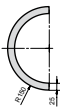



✓ = available while stocks last

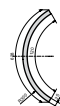

PAGE	ARTICLE	ARTICLE NR.	SPECIFICATION	FEATURE	AMOUNT WEIGHT (KG)	PIECE / PRICE	PRICE	PALETTE PRICE	
13	Fireclay pilaster strip 100/75/100	OR791-1	thickness 25 mm, height 1000 mm, rounding angle 135°		1 pc. = 13,66 kg	€ 72,90			
V									
13	Fireclay pilaster strip 100/105/100	OR792	thickness 25 mm, height 500 mm, rounding angle 135°		1 pc. = 7,69 kg	€ 39,90			
V									
13	Fireclay pilaster strip 100/105/100	OR792-1	thickness 25 mm, height 1000 mm, rounding angle 135°		1 pc. = 15,38 kg	€ 80,00			
V									
13	Fireclay pilaster strip 100/215/100	OR793	thickness 25 mm, height 500 mm, rounding angle 135°		1 pc. = 10,75 kg	€ 57,10			
V									
13	Fireclay pilaster strip 100/215/100	OR793-1	thickness 25 mm, height 1000 mm, rounding angle 135°		1 pc. = 21,5 kg	€ 114,10			
V									
13	Fireclay elbow 90°	OR794	thickness 25 mm, 150x150x500, radius = 70 mm		1 pc. = 6,88 kg	€ 36,30			
13	Fireclay elbow 90°	OR794-1	thickness 25 mm, 150x150x1000, radius = 70 mm		1 pc. = 13,76 kg	€ 72,90			
13	S-shaped fireclay pilaster strip	OR795	thickness 25 mm, 150x150x H = 500 mm, R1 = 100 mm, R2 = 125 mm		1 pc. = 7,82 kg	€ 39,30			
13	S-shaped fireclay pilaster strip	OR795-1	thickness 25 mm, 150x150x H = 1000 mm, R1 = 100 mm, R2 = 125 mm		1 pc. = 15,64 kg	€ 77,70			
14	Cast fireclay board VIVEG	OR720	625 x 500 x 25 mm		pc. = 13,00 palette = 40	€ 43,10	€ 1.560,00		
14	Cast fireclay board R10	OR70100	R 100, 500 mm		1 pc. = 8,6 kg	€ 76,50			
V									
14	Cast fireclay board R10	OR70100-1 **	R 100, 1.000 mm		1 pc. = 17,2 kg	€ 153,00			
V									
14	Cast fireclay radius R12,5	OR70125	R 125, 500 mm		1 pc. = 10,8 kg	€ 78,80			
V									

Colors marked with the letter „A“ must be tempered exclusively by means of the reducing agent.
* = special color only on order.

V = available while stocks last

PAGE	ARTICLE	ARTICLE NR.	SPECIFICATION	FEATURE	AMOUNT WEIGHT (KG)	PIECE / PALETTE	PRICE	PALETTE PRICE	
14	Cast fireclay radius R15	OR70150	R 150, 500 mm		1 pc. = 12,9 kg		€ 78,80		
V									
14	Cast fireclay radius R15	OR70150-1 **	R 150, 1.000 mm		1 pc. = 25,8 kg		€ 157,60		
V									
14	Cast fireclay radius R20	OR70200	R 200, 500 mm		1 pc. = 17,2 kg		€ 85,00		
V									
14	Cast fireclay radius R20	OR70200-1 **	R 200, 1.000 mm		1 pc. = 34,4 kg		€ 169,90		
V									
14	Cast fireclay radius R25	OR70250	R 250, 500 mm		1 pc. = 21,5 kg		€ 103,20		
V									
14	Cast fireclay radius R25	OR70250-1 **	R 250, 1.000 mm		1 pc. = 43,1 kg		€ 206,30		
V									
14	Cast fireclay radius R30	OR70300	R 300, 500 mm		1 pc. = 17,2 kg		€ 78,80		
14	Cast fireclay radius R30	OR70300-1 **	R 300, 1.000 mm		1 pc. = 34,4 kg		€ 157,60		
14	Cast fireclay radius R35	OR70350	R 350, 500 mm		1 pc. = 18,7 kg		€ 78,80		
V									
14	Cast fireclay radius R35	OR70350-1 **	R 350, 1.000 mm		1 pc. = 37,47 kg		€ 157,60		
V									
14	Cast fireclay radius R40	OR70400	R 400, 500 mm		1 pc. = 17,2 kg		€ 78,80		
14	Cast fireclay radius R40	OR70400-1 **	R 400, 1.000 mm		1 pc. = 34,4 kg		€ 157,60		
14	Cast fireclay radius R45	OR70450	R 450, 500 mm		1 pc. = 19,4 kg		€ 78,80		
V									







V = available while stocks last

PAGE	ARTICLE	ARTICLE NR.	SPECIFICATION	FEATURE	AMOUNT WEIGHT (KG)	PIECE / PRICE PALETTE	PALETTE PRICE
14	Cast fireclay radius R45	OR70450-1 **	R 450, 1.000 mm		1 pc. = 38,8 kg	€ 157,60	
✓							
14	Cast fireclay radius R50	OR70500	R 500, 500 mm		1 pc. = 17,2 kg	€ 80,00	
14	Cast fireclay board R50	OR70500-1 **	R 500, 1.000 mm		1 pc. = 34,4 kg	€ 160,30	
14	Cast fireclay radius R55	OR70550	R 550, 500 mm		1 pc. = 19 kg	€ 80,00	
✓							
14	Cast fireclay radius R55	OR70550-1 **	R 550, 1.000 mm		1 pc. = 38 kg	€ 160,30	
✓							
14	Cast fireclay radius R60	OR70600	R 600, 500 mm		1 pc. = 17,2 kg	€ 80,00	
14	Cast fireclay radius R60	OR70600-1 **	R 600, 1.000 mm		1 pc. = 34,4 kg	€ 160,30	
14	Cast fireclay radius R65	OR70650	R 650, 500 mm		1 pc. = 18,7 kg	€ 80,00	
✓							
14	Cast fireclay radius R65	OR70650-1 **	R 650, 1.000 mm		1 pc. = 37,4 kg	€ 160,30	
✓							
14	Cast fireclay radius R70	OR70700	R 700, 500 mm		1 pc. = 17,2 kg	€ 80,00	
14	Cast fireclay radius R70	OR70700-1 **	R 700, 1.000 mm		1 pc. = 34,4 kg	€ 160,30	
14	Cast fireclay radius R75	OR70750	R 750, 500 mm		1 pc. = 18,5 kg	€ 80,00	
✓							
14	Cast fireclay radius R75	OR70750-1 **	R 750, 1.000 mm		1 pc. = 36,9 kg	€ 160,30	
✓							







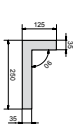
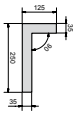
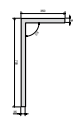
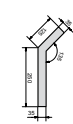
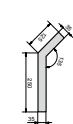
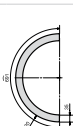

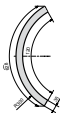
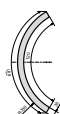
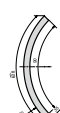
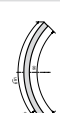

✓ = available while stocks last

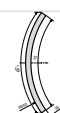











PAGE	ARTICLE	ARTICLE NR.	SPECIFICATION	FEATURE	AMOUNT WEIGHT (KG)	PIECE / PALETTE	PRICE	PALETTE PRICE	
14	Cast fireclay radius R80	OR70800	R 800, 500 mm		1 pc. = 17,2 kg		€ 80,00		
14	Cast fireclay radius R80	OR70800-1 **	R 800, 1.000 mm		1 pc. = 34,4 kg		€ 160,30		
14	Cast fireclay radius R90	OR70900	R 900, 500 mm		1 pc. = 17,2 kg		€ 80,00		
✓	14	Cast fireclay radius R90	OR70900-1 **	R 900, 1.000 mm	1 pc. = 34,4 kg		€ 160,30		
✓	14	Cast fireclay radius R100	OR71000	R 1.000, 500 mm	1 pc. = 17,2 kg		€ 80,00		
✓	14	Cast fireclay radius R100	OR71000-1 **	R 1.000, 1.000 mm	1 pc. = 34,4 kg		€ 160,30		
✓	15	Cast fireclay radius R125	OR71250	R 1.250, 500 mm	1 pc. = 17,9 kg		€ 80,00		
✓	15	Cast fireclay radius R125	OR71250-1 **	R 1.250, 1.000 mm	1 pc. = 35,9 kg		€ 160,30		
✓	15	Cast fireclay radius R150	OR71500	R 1.500, 500 mm	1 pc. = 17,2 kg		€ 80,00		
✓	15	Cast fireclay radius R150	OR71500-1 **	R 1.500, 1.000 mm	1 pc. = 34,4 kg		€ 160,30		
✓	15	Cast fireclay radius R200	OR72000	R 2.000, 500 mm	1 pc. = 17,2 kg		€ 80,00		
✓	15	Cast fireclay radius R200	OR72000-1 **	R 2.000, 1.000 mm	1 pc. = 34,4 kg		€ 160,30		
✓	15	Cast fireclay radius R300	OR73000	R 3.000, 500 mm	1 pc. = 17,2 kg		€ 80,00		

✓ = available while stocks last













PAGE	ARTICLE	ARTICLE NR.	SPECIFICATION	FEATURE	AMOUNT WEIGHT (KG)	PIECE / PALETTE	PRICE	PALETTE PRICE	
15	Cast fireclay radius R300	OR73000-1 **	R 3.000, 1.000 mm		1 pc. = 34,4 kg		€ 160,30		
V									
15	Cast fireclay radius R400	OR74000	R 4.000, 500 mm		1 pc. = 17,2 kg		€ 80,00		
15	Cast fireclay radius R400	OR74000-1 **	R 4.000, 1.000 mm		1 pc. = 34,4 kg		€ 160,30		
16	Stove board	OR605	LxHxB 500 x 250 x 35 mm		500 x 250 x 35 mm		€ 14,70	€ 1.106,80	
16	Stove board	OR601	LxHxB 1.000 x 250 x 35 mm		1.000 x 250 x 35 mm		€ 27,90	€ 1.060,80	
16	Stove board	OR602	LxHxB 1.000 x 500 x 35 mm		1.000 x 500 x 35 mm		€ 55,80	€ 1.060,80	
16	Stove board	OR603	LxHxB 750x 500 x 35 mm		750x 500 x 35 mm		€ 42,00	€ 1.212,00	
16	Elbow 90°	OR650	LxLxHxB 250 x 125 x 250 x 35 mm		1 pc. = = 3,6 kg, 1 palette = 40 Stk.		€ 30,30	€ 1.152,80	
16	Elbow 90°	OR652	LxLxHxB 250 x 125 x 500 x 35 mm		1 pc. = = 7,2 kg, 1 palette = 40 Stk.		€ 49,60	€ 1.882,70	
16	Elbow 90°	OR651	LxLxHxB 700 x 350 x 500 x 35 mm		1 pc. = = 24,5 kg, 1 palette = 14 Stk.		€ 72,90	€ 968,30	
16	Elbow 135°	OR660	LxLxHxB 250 x 125 x 250 x 35 mm		1 pc. = = 4,7 kg, 1 palette = 36 Stk.		€ 30,30	€ 1.037,70	
16	Elbow 135°	OR661	LxLxHxB 250 x 125 x 500 x 35 mm		1 pc. = 9,4 kg, 1 palette = 36 Stk.		€ 49,60	€ 1.694,50	
16	Radius R22	OR60220	LxLxHxB 500 x 35 mm		1 pc. = = 14,5		€ 63,90	€ 484,40	

V = available while stocks last

PAGE	ARTICLE	ARTICLE NR.	SPECIFICATION	FEATURE	AMOUNT WEIGHT (KG)	PIECE / PALETTE	PRICE	PALETTE PRICE	
16	Radius R30	OR60300	LxLxHxB 250 x 35 mm		1 pc. = 6,40	€ 39,50	€ 637,00		
16	Radius R33	OR60330	LxLxHxB 500 x 35 mm		1 pc. = 14,9	€ 63,90	€ 970,60		
16	Radius R40	OR60400	LxLxHxB 250 x 35 mm		1 pc. = 6,60	€ 39,50	€ 824,30		
16	Radius R44	OR60440	LxLxHxB 500 x 35 mm		1 pc. = 15,1	€ 63,90	€ 1.213,30		
16	Radius R50	OR60500	LxLxHxB 250 x 35 mm		1 pc. = 6,20	€ 39,90	€ 951,20		
16	Radius R55	OR60550	LxLxHxB 500 x 35 mm		1 pc. = 15,2	€ 65,00	€ 1.419,40		
16	Radius R60	OR60600	LxLxHxB 250 x 35 mm		1 pc. = 6,20	€ 39,90	€ 989,10		
16	Radius R65	OR60650	LxLxHxB 500 x 35 mm		1 pc. = 15,1	€ 65,00	€ 1.419,40		
16	Bearing stone	OR680	L-shaped bearing stone, thickness 35 mm	100 x 70 x 500 mm	1 pc. = 3,5 kg, 1 palette = 40 pcs.	€ 21,60	€ 820,20		
17	Accumulation board	OR607	LxHxB 500 x 250 x 35 mm		1 pc. = 11,5 kg, 1 palette = 80 pcs.	€ 26,70	€ 936,00		
17	Fireclay lintel beam	OR790	600 x 150 x 1.200 mm		Stk. = 15,00	€ 43,70			
17	Fireclay frame and lid	OR7813RSet	Round frame 220x220 mm and straight, round lid ø 135 mm		1 pc. = 3,72 kg	€ 36,50			
17	Fireclay frame and lid	OR7813Set	Square frame 220x220 mm and straight, square lid ø 135 mm		1 pc. = 2,76 kg	€ 36,50			













PAGE	ARTICLE	ARTICLE NR.	SPECIFICATION	FEATURE	AMOUNT WEIGHT (KG)	PIECE / PRICE PALETTE	PRICE	PALETTE PRICE	
17	Fireclay frame and lid	OR7818Set	Square frame 300x300 mm and straight, square lid \varnothing 190 mm		1 pc. = 5,26 kg		€ 36,50		
17	Fireclay lid spare part	OR7813E	220x220 mm and straight				€ 10,40		
17	Fireclay lid spare part	OR7818E	300x300 mm and straight,				€ 10,40		
17	Fireclay linking element	OR70-160	160 \varnothing , cast iron/iron pipe		1 pc. = 4,6 kg		€ 49,80		
17	Fireclay linking element	OR70-180	180 \varnothing , cast iron/iron pipe		1 pc. = 5,4 kg		€ 49,80		
17	Fireclay linking element	OR70-180 HT	180 \varnothing , HT iron pipe		1 pc. = 7,7 kg		€ 54,70		
17	Fireclay linking element	OR70-200 HT	200 \varnothing , HT iron pipe		1 pc. = 8,3 kg		€ 54,70		
17	3S Cleaning lid	OR3S-26ST	250 x 200 x 64 mm		1 pc.		€ 10,90		
18	Universal board	OR710H	1.250 x 870 x 12,5 mm		1 pc. = 16 kg; 1 palette = 25 pcs.		€ 42,60	€ 1.017,00	
18	Universal board	OR711H	1.250 x 430 x 12,5 mm		1 pc. = 8 kg; 1 palette = 50 pcs.		€ 23,00	€ 1.069,20	
18	UP Radius 10	OR70100H	Radius 10 cm, 314 x 500 mm, strength 12,5 mm, circle part n=2		1 pc. = 3,9 kg		€ 57,00		
18	UP Radius 15	OR70150H	Radius 15 cm, 471 x 500 mm, strength 12,5 mm, circle part n=2		1 pc. = 6,1 kg		€ 59,60		
18	UP Radius 20	OR70200H	Radius 20 cm, 314 x 500 mm, strength 12,5 mm, circle part n=4		1 pc. = 4,1 kg		€ 32,90		

PAGE	ARTICLE	ARTICLE NR.	SPECIFICATION	FEATURE	AMOUNT WEIGHT (KG)	PIECE / PALETTE	PRICE	PALETTE PRICE
18	UP Radius 25	OR70250H	Radius 25 cm, 393 x 500 mm, strength 12,5 mm, circle part n=4		1 pc. = 5,45 kg	€ 38,80		
18	UP Radius 30	OR70300H	Radius 30 cm, 471 x 500 mm, strength 12,5 mm, circle part n=4		1 pc. = 5,6 kg	€ 30,30		
18	UP Radius 35	OR70350H	Radius 35 cm, 367 x 500 mm, strength 12,5 mm, circle part n=6		1 pc. = 4,8 kg	€ 30,30		
18	UP Radius 40	OR70400H	Radius 40 cm, 628 x 500 mm, strength 12,5 mm, circle part n=4		1 pc. = 6,45 kg	€ 30,30		
18	UP Radius 50	OR70500H	Radius 50 cm, 628 x 500 mm, strength 12,5 mm, circle part n=5		1 pc. = 6,5 kg	€ 59,60		
18	UP Radius 60	OR70600H	Radius 60 cm, 28 x 500 mm, strength 12,5 mm, circle part n=6		1 pc. = 7,9 kg	€ 59,60		
18	UP Radius 70	OR70700H	Radius 70 cm, 628 x 500 mm, strength 12,5 mm, circle part n=7		1 pc. = 8,2 kg	€ 59,60		
18	UP Radius 100	OR71000H	Radius 100 cm, 628 x 500 mm, strength 12,5 mm, circle part n=10		1 pc. = 9,1 kg	€ 59,60		
18	Inner elbow	OR751	90°, Inner elbow Normformat 110 x 110 x 500 mm, Stärke 25/12,5 mm		1 pc. = 4,50	€ 29,10		
18	Inner elbow	OR751-1	90°, Inner elbow 110 x 110 x 1.000 mm, strength 25/12,5 mm		1 pc. = 9,00	€ 58,10		
18	Outer elbow	OR752	90°, Outer elbow 110 x 110 x 500 mm, strength 25/12,5 mm		1 pc. = 4,50	€ 29,10		
18	Outer elbow	OR752-1	90°, Outer elbow 110 x 110 x 1.000 mm, strength 25/12,5 mm		1 pc. = 9,00	€ 58,10		
18	Inner elbow	OR761	135°, Inner elbow 110 x 110 x 500 mm, strength 25/12,5 mm		1 pc. = 4,50	€ 29,10		













PAGE	ARTICLE	ARTICLE NR.	SPECIFICATION	FEATURE	AMOUNT WEIGHT (KG)	PIECE / PALETTE	PRICE	PALETTE PRICE	
18	Inner elbow	OR761-1	135°, Inner elbow 110 x 110 x 1.000 mm, strength 25/12,5 mm		1 pc. = 9,00		€ 58,10		
18	Outer elbow	OR762	135°, Outer elbow 110 x 110 x 500 mm, strength 25/12,5 mm		1 pc. = 4,50		€ 29,10		
18	Outer elbow	OR762-1	135°, Outer elbow 110 x 110 x 1.000 mm, strength 25/12,5 mm		1 pc. = 9,00		€ 58,10		
24	ORTNER GOR44 manual control	GOR44KH	GOR44 small doors 31,5 x 50,5 * standard				€ 2.407,90		
24	ORTNER GOR44 automatic	GOR44KA	GOR44 small doors 31,5 x 50,5 * standard				€ 2.479,50		
24	Additional function: self closing and/or self	OR-APTUER	surcharge for Self closing and/or self locking doors				€ 164,20		
24	Gold frame	OR-GTO-APK2	surcharge for small, straight doors				€ 45,00		
24	Gold points	OR-GTO-APK3	surcharge for small, straight doors				€ 49,30		
V	White frame	OR-GTO-APK4	surcharge for small, straight doors				€ 0,00		
24	White points	OR-GTO-APK5	surcharge for small, straight doors				€ 3,00		
V	Steel bezel straight	OR-SBK	for small doors				€ 162,40		
V	Steel bezel straight, wide	OR-SBKR	for small doors, wide bezel				€ 162,40		
24	Steel bezel rounded	OR-SBK6	ø 600 mm, for small doors, rounded				€ 264,30		

V













V = available while stocks last

PAGE	ARTICLE	ARTICLE NR.	SPECIFICATION	FEATURE	AMOUNT WEIGHT (KG)	PIECE / PALETTE	PRICE	PALETTE PRICE
24	Steel bezel rounded, wide	OR-SBK6R	ø 600 mm, for small doors, rounded, wide				€ 264,30	
24	Stove control LED	OR-STL	Combustion control with LED screen				€ 676,00	
24	Stove control Bluetooth (APP)	OR-STB	Combustion control with LED screen and data transfer module (APP) **				€ 780,00	
25	Automatic control LED/ APP	OR-LRA1-LB	Automatic airflow control consists of combustion air flap with actuator ø 125, with flexible aluminum pipe, hose clip (2 pcs.); air grid				€ 457,00	
25	Automatic control LED/ APP	OR-LRA2-LB	Automatic airflow control with combustion air box and actuator ø 125				€ 585,90	
25	Manual control	OR-LRH1	Outside size 14,5 x 32,5 cm, RO manual airflow control consists of rectangular air box, air grid, flexible aluminum pipe, hose clip (2 pcs.)				€ 191,60	
25	Manual control	OR-LRH2	Outside size 23 x 23 cm, RO manual airflow control consists of rectangular air box, air grid, flexible aluminum pipe, hose clip (2 pcs.)				€ 113,40	
25	Accessories set ø 600	OR-BSET	Frame for ceramic, height 10 cm, ø 680, bezel for base, wall rosette, ceramic stove rosette and pipe 50 cm, ø 120				€ 487,10	
25	Accessories set ø 700	OR-BSET70	Frame for ceramic, height 10 cm, ø 680, bezel for base, wall rosette, ceramic stove rosette and pipe 50 cm, ø 120				€ 495,20	
26	ORTNER GOR44 manual control	GOR44GH	GOR44 large doors straight 43 x 51 * standard				€ 2.836,10	
26	ORTNER GOR44 automatic	GOR44GA	GOR44 large doors straight 43 x 51 * standard				€ 2.908,80	
26	ORTNER GOR44 manual control	GOR44RH	GOR44 large doors rounded 43 x 51 * standard				€ 3.098,20	
26	ORTNER GOR44 automatic	GOR44RA	GOR44 large doors rounded 43 x 51 * standard				€ 3.163,20	

V = available while stocks last















PAGE	ARTICLE	ARTICLE NR.	SPECIFICATION	FEATURE	AMOUNT WEIGHT (KG)	PIECE / PALETTE	PRICE	PALETTE PRICE
	24	Additional function: self closing and/or self	OR-APTUER	surcharge for Self closing and/ or self locking doors			€ 164,20	
	26	Black points, with full frame	OR-GTO-APG2	surcharge for large, straight doors			€ 8,90	
	26	White points, with full frame	OR-GTO-APG5	surcharge for large, straight doors			€ 8,90	
	26	White points, with full frame	OR-GTO-APR5	surcharge for large, rounded doors			€ 23,30	
	26	Steel bezel straight	OR-SBG	for large, straight doors			€ 162,40	
	26	Steel bezel wide	OR-SBGR	for large doors, wide bezel			€ 162,40	
	26	Steel bezel rounded	OR-SBG6	ø 600 mm, for large doors, rounded			€ 257,60	
	26	Steel bezel rounded, wide	OR-SBG6R	ø 600 mm, for large doors, wide bezel			€ 264,30	
	26	Steel bezel rounded	OR-SBG7	ø 700 mm, for large doors			€ 264,30	
	26	Steel bezel rounded	OR-SBG10	ø 1000 mm, for large doors			€ 264,30	
	26	Stove control LED	OR-STL	Combustion control with LED screen			€ 676,00	
	26	Stove control Bluetooth (APP)	OR-STB	Combustion control with LED screen and data transfer module (APP) **			€ 780,00	
	27	Automatic control LED/ APP	OR-LRA1-LB	Automatic airflow control consists of combustion air flap with actuator ø 125, with flexible aluminum pipe, hose clip (2 pcs.); air grid			€ 457,00	

V = available while stocks last















PAGE	ARTICLE	ARTICLE NR.	SPECIFICATION	FEATURE	AMOUNT WEIGHT (KG)	PIECE / PALETTE	PRICE	PALETTE PRICE
27	Automatic control LED/APP	OR-LRA2-LB	Automatic airflow control with combustion air box and actuator ø 125				€ 585,90	
27	Manual control	OR-LRH1	Outside size 14,5 x 32,5 cm, RO manual airflow control consists of rectangular air box, air grid, flexible aluminum pipe, hose				€ 191,60	
27	Manual control	OR-LRH2	Outside size 23 x 23 cm, RO manual airflow control consists of rectangular air box, air grid, flexible aluminum pipe, hose				€ 113,40	
27	Accessories set ø 600	OR-BSET	Frame for ceramic, height 10 cm, ø 680, bezel for base, wall rosette, ceramic stove rosette and pipe 50 cm, ø 120				€ 487,10	
27	Accessories set ø 700	OR-BSET70	Frame for ceramic, height 10 cm, ø 680, bezel for base, wall rosette, ceramic stove rosette and pipe 50 cm, ø 120				€ 495,20	
28	ORTNER Grundofen 8T	GO8T-GTA	automatic control, straight doors (43x51 cm) * standard				€ 4.071,10	
28	ORTNER Grundofen 8T	GO8T-GTH	manual control, straight doors (43 x 51 cm) * standard				€ 3.991,60	
28	ORTNER Grundofen 8T	GO8T-GRTA	automatic control, large, rounded doors (43 x 51 cm) * standard				€ 4.609,00	
28	ORTNER Grundofen 8T	GO8T-GRTH	manual control, large, rounded doors (43 x 51 cm) * standard				€ 4.529,70	
28	ORTNER Grundofen 8T	GO8T-GRGTA	automatic control, large rounded and straight doors (43 x 51 cm) * standard				€ 4.340,00	
28	ORTNER Grundofen 8T	GO8T-GRGTH	manual control, large rounded and straight doors (43 x 51 cm) * standard				€ 4.260,70	
28	Additional function: self closing and/or self	OR-APTUER	surcharge for Self closing and/or self locking doors				€ 164,20	
28	Black points with full frame	OR-GTO-APG2	surcharge for large, straight doors				€ 8,90	

V













V = available while stocks last

PAGE	ARTICLE	ARTICLE NR.	SPECIFICATION	FEATURE	AMOUNT WEIGHT (KG)	PIECE / PALETTE	PRICE	PALETTE PRICE
	28	White points with full frame	OR-GTO-APG5	surcharge for large, straight doors			€ 8,90	
	V							
	28	White points with full frame	OR-GTO-APR5	surcharge for large, rounded doors			€ 23,30	
	V							
	28	Steel bezel straight	OR-SBG	for large, straight doors			€ 162,40	
	V							
	28	Steel bezel wide	OR-SBGR	for large doors, wide bezel			€ 162,40	
	28	Steel bezel rounded	OR-SBG7	ø 700 mm, for large doors			€ 264,30	
	V							
	28	Stove control LED	OR-STL	Combustion control with LED screen			€ 676,00	
	28	Stove control Bluetooth (APP)	OR-STB	Combustion control with LED screen and data transfer module (APP) **			€ 780,00	
	29	Automatic control LED/ APP	OR-LRA1-LB	Automatic airflow control consists of combustion air flap with actuator ø 125, with flexible aluminum pipe, hose clip (2 pcs.); air grid			€ 457,00	
	29	Automatic control LED/ APP	OR-LRA2-LB	Automatic airflow control with combustion air box and actuator ø 125			€ 585,90	
	29	Manual control	OR-LRH1	Outside size 14,5 x 32,5 cm, RO manual airflow control consists of rectangular air box, air grid, flexible aluminum pipe, hose clip (2 pcs.)			€ 191,60	
	29	Manual control	OR-LRH2	Outside size 23 x 23 cm, RO manual airflow control consists of rectangular air box, air grid, flexible aluminum pipe, hose			€ 113,40	
	30	ORTNER G08	G08-GTA	automatic control, straight doors (43x51 cm) * standard			€ 3.087,40	
	30	ORTNER G08	G08-GTH	manual control, straight doors (43 x 51 cm) * standard			€ 3.008,00	
	30	ORTNER G08	G08-GRTA	automatic control, large, rounded doors (43 x 51 cm) * standard			€ 3.356,40	













V = available while stocks last













PAGE	ARTICLE	ARTICLE NR.	SPECIFICATION	FEATURE	AMOUNT WEIGHT (KG)	PIECE / PALETTE	PRICE	PALETTE PRICE
30	ORTNER G08	GO8-GRTH	manual control, large, rounded doors (43 x 51 cm) * standard				€ 3.276,90	
30	Additional function: self closing and/or self	OR-APTUER	surcharge for Self closing and/or self locking doors				€ 164,20	
30	Black points with full frame	OR-GTO-APG2	surcharge for large, straight doors				€ 8,90	
30	White points with full frame	OR-GTO-APG5	surcharge for large, straight doors				€ 8,90	
30	White points with full frame	OR-GTO-APR5	surcharge for large, rounded doors				€ 23,30	
30	Steel bezel straight	OR-SBG	for large, straight doors				€ 162,40	
30	Steel bezel wide	OR-SBGR	for large doors, wide bezel				€ 162,40	
30	Steel bezel rounded	OR-SBG7	ø 700 mm, for large doors				€ 264,30	
30	Stove control LED	OR-STL	Combustion control with LED screen				€ 676,00	
30	Stove control Bluetooth (APP)	OR-STB	Combustion control with LED screen and data transfer module (APP) **				€ 780,00	
31	Automatic control LED/ APP	OR-LRA1-LB	Automatic airflow control consists of combustion air flap with actuator ø 125, with flexible aluminum pipe, hose clip (2 pcs.); air grid				€ 457,00	
31	Automatic control LED/ APP	OR-LRA2-LB	Automatic airflow control with combustion air box and actuator ø 125				€ 585,90	
31	Manual control	OR-LRH1	Outside size 14,5 x 32,5 cm, RO manual airflow control consists of rectangular air box, air grid, flexible aluminum pipe, hose clip (2 pcs.)				€ 191,60	
31	Manual control	OR-LRH2	Outside size 23 x 23 cm, RO manual airflow control consists of rectangular air box, air grid, flexible aluminum pipe, hose clip (2 pcs.)				€ 113,40	

V = available while stocks last













PAGE	ARTICLE	ARTICLE NR.	SPECIFICATION	FEATURE	AMOUNT WEIGHT (KG)	PIECE / PRICE PALETTE	PRICE	PALETTE PRICE
32	ORTNER Grundofen GO15	GO15-GT	automatic control, straight doors (43x51 cm) * standard				€ 3.921,70	
32	ORTNER Grundofen GO15	GO15-RT	automatic control, rounded doors (43 x 51 cm) * standard				€ 4.184,90	
32	Additional function: self closing and/or self	OR-APTUER	surcharge for Self closing and/ or self locking doors				€ 164,20	
32	Black points with full frame	OR-GTO-APG2	surcharge for large, straight doors				€ 8,90	
32	White points with full frame	OR-GTO-APG5	surcharge for large, straight doors				€ 8,90	
32	White points with full frame	OR-GTO-APR5	surcharge for large, rounded doors				€ 23,30	
32	Steel bezel straight	OR-SBG10	(E) Steel bezel straight Ø 1000 mm				€ 264,30	
32	Steel bezel wide	OR-SBG	(F) Steel bezel wide				€ 162,40	
30	Steel bezel rounded	OR-SBGR	(G) Steel bezel rounded				€ 162,40	
32	Stove control LED	OR-STL	Combustion control with LED screen				€ 676,00	
32	Stove control Bluetooth (APP)	OR-STB	Combustion control with LED screen and data transfer module (APP) **				€ 780,00	
33	Automatic control LED/ APP	OR-LGA1-LB	Automatic airflow control GO consists of combustion air box with actuator , 2 x Ø 100 connectors, 2 x flexible aluminum pipe plus hose clip (4 pc.); air grid				€ 616,00	
36	Set Grundofen GOR44	GOR-SETKAO	Automatic, GOR44 with small doors + 6 KAM + Accumulation cover with a top opening, Ø 120 – excl. bezel				€ 3.645,00	













V = available while stocks last











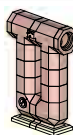

PAGE	ARTICLE	ARTICLE NR.	SPECIFICATION	FEATURE	AMOUNT WEIGHT (KG)	PIECE / PALETTE	PRICE	PALETTE PRICE
36	Set Grundofen GOR44	GOR-SETKAS	Automatic, GOR44 with small doors + 5 KAM + Accumulation cover with a side opening, Ø 120 – excl. bezel				€ 3.645,00	
36	Set Grundofen GOR44	GOR-SETKHO	Manual, GOR44 with small doors + 6 KAM + Accumulation cover with a top opening, Ø 120 – excl. bezel				€ 3.246,60	
36	Set Grundofen GOR44	GOR-SETKHS	Manual, GOR44 with small doors + 5 KAM + Accumulation cover with a side opening, Ø 120 – excl. bezel				€ 3.246,60	
36	Set Grundofen GOR44	GOR-SETGAO	Automatic, GOR44 with big, straight doors + 6 KAM + Accumulation cover with a top opening, Ø 120 – excl. Bezel				€ 3.805,00	
36	Set Grundofen GOR44	GOR-SETGAS	Automatic, GOR44 with big, straight doors + 5 KAM + Accumulation cover with a side opening, Ø 120 – excl. bezel				€ 3.805,00	
36	Set Grundofen GOR44	GOR-SETGHO	Manual, GOR44 with big, straight doors + 6 KAM + Accumulation cover with a side opening, Ø 120 – excl. bezel				€ 3.357,40	
36	Set Grundofen GOR44	GOR-SETGHS	Manual, GOR44 with big, straight doors + 5 KAM + Accumulation cover with a side opening, Ø 120 – excl. Bezel				€ 3.357,40	
37	Set Grundofen GOR44	GOR-SETRAO	Automatic, GOR44 with big, round doors + 6 KAM + Accumulation cover with a top opening, Ø 120 – excl. bezel				€ 3.973,90	
37	Set Grundofen GOR44	GOR-SETRAS	Automatic, GOR44 with big, round doors + 5 KAM + Accumulation cover with a side opening, Ø 120 – excl. bezel				€ 3.973,90	
37	Set Grundofen GOR44	GOR-SETRHO	Manual, GOR44 with big, round doors + 6 KAM + Accumulation cover with a top opening, Ø 120 – excl. bezel				€ 3.562,00	
37	Set Grundofen GOR44	GOR-SETRHS	Manual, GOR44 with big, round doors + 5 KAM + Accumulation cover with a side opening, Ø 120 – excl. bezel				€ 3.562,00	
37	Accessories set Ø 600	OR-BSET	Frame for ceramic, height 10 cm, Ø 680, bezel for base, wall rosette, ceramic stove rosette and pipe 50 cm, Ø 120				€ 487,10	
37	Accessories set Ø 700	OR-BSET70	Frame for ceramic, height 10 cm, Ø 680, bezel for base, wall rosette, ceramic stove rosette and pipe 50 cm, Ø 120				€ 495,20	

PAGE	ARTICLE	ARTICLE NR.	SPECIFICATION	FEATURE	AMOUNT WEIGHT (KG)	PIECE / PRICE PALETTE	PALETTE PRICE
38	Kitchen stove model 1	OR-HO1	113,1 x 102,5 cm 62,3 dm ²		360 kg	€ 2.869,00	
38	Kitchen stove model 2	OR-HO2	125,8 x 115,2 cm 80,1 dm ²		433 kg	€ 3.350,70	
38	Kitchen stove model 3	OR-HO3	138,5 x 127,9 cm 98,7 dm ²		509 kg	€ 3.898,40	
38	Kitchen stove model 4	OR-HO4	151,2 x 140,6 cm 118,8 dm ²		591 kg	€ 4.449,50	
38	Ashtray	OR-HZ3	Kitchen stove steel ashtray		7,0 kg	€ 520,60	
38	Connection adapter	OR-HZ1	Kitchen stove connection adapter		10,0 kg	€ 260,30	
38	Doors	OR-HZ2	Kitchen stove steel doors		7,5 kg	€ 580,30	
38	Chimney cap	OR-HZ5	Kitchen stove chimney cap		3,5 kg	€ 149,70	
38	Switch	OR4S-W101	Switch		0,5 kg	€ 172,60	
39	KAM Accumulation disc up to 700°C	OR-S20	Ø 444 x 100 mm		pc. = 25,00	€ 185,90	
39	KAM Two-piece accumulation disc up to 1000°C	OR-S50	Ø 444 x 100 mm		pc. = 22,00	€ 284,60	
39	KAM Two-piece accumulation disc up to	OR-S50F	Ø 444 x 100 mm, disc with integrated thermal sensor incl. ceramic protective cover		pc. = 22,00	€ 388,10	
39	Accumulation cover with side opening, Ø =	OR-S30120	Ø 444 x 200 mm, opening 120 mm, top and bottom part		pc. = 42,00 1 Set = 2 pc.	€ 351,40	













PAGE	ARTICLE	ARTICLE NR.	SPECIFICATION	FEATURE	AMOUNT WEIGHT (KG)	PIECE / PALETTE	PRICE	PALETTE PRICE
39	Accumulation cover with top opening, $\varnothing =$	OR-S20120	$\varnothing 444 \times 100$ mm		pc. = 25,00		€ 175,80	
39	Accumulation cover with side opening, $\varnothing =$	OR-S30160	$\varnothing 444 \times 200$ mm, opening 160 mm, top and bottom part		pc. = 46,00 1 Set = 2 pc.		€ 351,40	
39	Accumulation cover with top opening, $\varnothing =$	OR-S20160	$\varnothing 444 \times 100$ mm, opening 160 mm		pc. = 25,00		€ 175,80	
39	Accumulation cover with side opening, $\varnothing =$	OR-S30180	$\varnothing 444 \times 200$ mm, opening 180 mm		pc. = 47,00 1 Set = 2 pc.		€ 351,40	
39	Accumulation cover with top opening, $\varnothing =$	OR-S20180	$\varnothing 444 \times 100$ mm		pc. = 25,00		€ 175,80	
39	Accumulation cover with side opening, $\varnothing =$	OR-S30200	$\varnothing 444 \times 200$ mm, opening 200 mm, top and bottom part		Stk. = 49,00		€ 351,40	
39	Accumulation cover with top opening, $\varnothing =$	OR-S20200	$\varnothing 444 \times 100$ mm, opening 200 mm		pc. = 25,00		€ 175,80	
39	Accumulation connector cover	OR-KMS001000	(A) Accumulation cover $\varnothing 160$ and (B) pipe HT $\varnothing 160$ manual control		pc. = 54,00		€ 590,70	
39	Accumulation connector cover	OR-KMS002000	(A) Accumulation cover $\varnothing 160$ and (B) pipe HT $\varnothing 160$ automatic control*		pc. = 54,00		€ 695,80	
39	Accumulation connector cover	OR-KMS003000	(A) Accumulation cover $\varnothing 180$ and (B) pipe HT $\varnothing 180$ manual control		pc. = 54,00		€ 601,10	
39	Accumulation connector cover	OR-KMS004000	(A) Accumulation cover $\varnothing 180$ and (B) pipe HT $\varnothing 180$ automatic control*		pc. = 54,00		€ 704,50	
40	KMS300 connector	OR4S-R10	300 x 300 x 100 mm, $\varnothing 180$ mm		pc. = 12,50		€ 61,10	
40	KMS300 pipe	OR4S-R20	300 x 300 x 200 mm, $\varnothing 180$ mm	300 x 300 x 200 $\varnothing 180$ mm	Stk. = 25,00		€ 87,40	













PAGE	ARTICLE	ARTICLE NR.	SPECIFICATION	FEATURE	AMOUNT WEIGHT (KG)	PIECE / PALETTE	PRICE	PALETTE PRICE	
40	KMS300 bend 90°	OR4S-K90	300 x 300 x 300 mm, Ø 180 mm	300 x 300 x 300 Ø 180 mm	pc. = 33,00		€ 115,50		
40	KMS300 bend 135°	OR4S-K135	300 x 300 x 273 mm, Ø 180 mm	300 x 300 x 273 Ø 180 mm	pc. = 25,00		€ 112,80		
40	KMS300 T- piece, Ø 180 mm	OR4S-T180	300 x 300 x 300 mm, Ø180 mm, incl. ring	300 x 300 x 300 Ø 180 mm, inkl. Ring	pc. = 30,00		€ 122,50		
40	KMS300 with opening	OR4S-R23	300 x 300 x 100 mm with opening	300 x 300 x 200 Ø 180 mm	pc. = 25,00		€ 137,20		
40	KMS300 bend 90°	OR4S-K92	with side opening, 300 x 300 mm, Ø 180 mm, incl. cleaning lid nr 2 and ring		300 x 300, Ø 180 mm, inkl. Putzdeckel Nr. 2 und Ring		€ 164,90		
40	KMS300 bend 90°	OR4S-K93	with side opening, 300 x 300 mm, Ø 180 mm, incl. cleaning lid nr 1 and ring		300 x 300, Ø 180 mm		€ 164,90		
40	KMS300 cleaning lid 1	OR4S-PD1	KMS 300 cleaning lid 1 top	KMS-300 cleaning lid 1	pc. = 1,60		€ 38,20		
40	KMS300 cleaning lid 2	OR4S-PD2	KMS 300 cleaning lid 2 side	KMS-300 cleaning lid 2	pc. = 1,60		€ 38,20		
40	KMS300 frame and cleaning lid, type T	OR4S-PG	KMS 300 T-piece	KMS-300 T-piece	pc. = 3,00		€ 78,80		
40	KMS300 pipe bypass	OR4S-R22-30	with bypass 30 mm, 300 x 300 x 200 mm, Ø 180 mm, incl. construction element, opening 30 mm		300 x 300 x 200 Ø 180 mm, inkl. Bauteil Loch		€ 135,90		
40	KMS300 pipe bypass	OR4S-R22-40	with bypass 40 mm, 300 x 300 x 200 mm, Ø 180 mm, incl. opening 30 mm		300 x 300 x 200 Ø 180 mm inkl. Bauteil Loch		€ 135,90		
40	KMS300 2 pcs. bypass for KMS	OR4S-BYPASS-30	KMS 300 2 pcs. for pipes and bends, bypass 30 mm		Bypass 30 mm		€ 76,50		
40	KMS300 bend 90°	OR4S-K94-30	with bypass 30 mm on top, 300 x 300 x 300 mm, Ø 180 mm, incl. construction element and ring, opening 30 mm		300 x 300 x 300 Ø D180 mm inkl. Bau- teil und Ring,		€ 165,00		







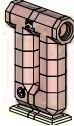





PAGE	ARTICLE	ARTICLE NR.	SPECIFICATION	FEATURE	AMOUNT WEIGHT (KG)	PIECE / PALETTE	PRICE	PALETTE PRICE	
40	KMS 300 bend 90°	OR4S-K94-40	with bypass 40 mm on top, 300 x 300 x 300 mm, ø 180 mm, incl. construction element and ring, opening 40 mm		300 x 300 x 300 ø 180 mm inkl. Bau- teil und Ring,	€ 165,00			
40	KMS 300 2 pcs. bypass for KMS	OR4S-BYPASS-40	KMS 300 2 pc. for pipes and bends, bypass 40 mm	Bypass 40 mm	Set = 2,50	€ 76,50			
40	KMS 300 bend 90°	OR4S-K95-30	with bypass 30 mm on side, 300 x 300 x 300 mm, ø 180 mm, incl. construction element and ring, opening 30 mm		300 x 300 x 300 ø 180 mm inkl. Bauteil u. Ring, Loch 30	€ 165,00			
41	KMS 300 bend 90°	OR4S-K95-40	with bypass 40 mm on top, 300 x 300 x 300 mm, ø 180 mm, incl. construction element and ring, opening 40 mm		300 x 300 x 300 ø 180 mm inkl. Bauteil u. Ring, Loch 40	€ 165,00			
41	KMS 300 connector	OR4S-EA16	KMS 300 for steel pipes, ø 160 mm, 300 x 300 x 100 mm	300 x 300 x 100	pc. = 10,00	€ 58,10			
41	KMS 300 connector	OR4S-EA7	KMS 300 for steel pipes, ø 180 mm, 300 x 300 x 70 mm	300 x 300 x 70	pc. = 7,50	€ 38,80			
41	KMS 300 ring	OR4S-R	KMS 300 ring	KMS-300 Ring	pc. = 0,50	€ 15,80			
41	KMS 300 concrete block	OR4S-AGS	KMS 300 concrete block, 200 x 100 x 100 mm	200 x 100 x 100	pc. = 10,00	€ 58,10			
41	KMS 300 connector	OR4S-R11	KMS 300 connector with non return flap valve, 300 x 300 x 100 mm, ø 180 mm		300 x 300 x 100, ø 180 mm	€ 196,30			
41	KMS 300 fle- xible elbow	OR4S-W101	with switch		pc. = 0,5	€ 172,60			
41	KMS 300 accumulation filler	OR4S-S25	for filling up empty spaces within ac- cumulation		sack = 25,00	€ 42,60			
41	affle 2 for KMS 300	OR4S-DS2	affle 2 for KMS 300		pc. = 1,40	€ 31,30			









PAGE	ARTICLE	ARTICLE NR.	SPECIFICATION	FEATURE	AMOUNT WEIGHT (KG)	PIECE / PRICE PALETTE	PALETTE PRICE
41	baffle 5 for KMS 300	OR4S-DS5	baffle 5 for KMS 300		pc. = 1,60	€ 32,40	
41	baffle 7 for KMS 300	OR4S-DS7	baffle 7 for KMS 300		pc. = 1,90	€ 34,10	
41	KMS bypass 300-240	OR4S-KA240	standing adapter 300-240 300 x 300 x 100, Ø 180 – Ø 160 mm		300 x 300 x 100 Ø180-Ø160 mm	€ 115,60	
41	temperature sensor	OR-TE4	thermal element 4lf with ceramic guard.		pc. = 1,0	€ 106,10	
41	KMS NHK 300	OR4S-NHK300	KMS-300 Reheating box set		pc. = 247,1	€ 1.048,60	
41	KMS NHK 300 with pre-heat path	OR4S-NHF300	KMS-300 Reheating box set with preheat path		pc. = 333,4	€ 1.605,60	
41	BIS 300 Vertical corner	OR-BIS-EH	300 x 300 x 80 mm		pc. = 5,30	€ 23,00	
41	BIS 300 Horizontal corner	OR-BIS-EL	300 x 300 x 80 mm		pc. = 5,30	€ 23,00	
41	BIS 300 Horizontal corner 135°	OR-BIS-135	300 x 80 mm		pc. = 3,50	€ 23,00	
41	BIS 300 Vertical element 10 cm	OR-BIS-LH	300 x 100 x 80 mm		pc. = 1,80	€ 13,20	
41	BIS 300 Vertical element 20 cm	OR-BIS-L	300 x 200 x 80 mm		pc. = 3,50	€ 23,00	
42	KMS 240 pipe	OR4S-R08K	KMS 240 pipe 80 mm		240 x 240 x 80 Ø 160 mm	€ 34,60	
42	KMS 240 pipe	OR4S-R16K	KMS 240 pipe 160 mm		240 x 240 x 160 Ø 160 mm	€ 49,80	









V = Verfügbar, solange der Vorrat reicht

PAGE	ARTICLE	ARTICLE NR.	SPECIFICATION	FEATURE	AMOUNT WEIGHT (KG)	PIECE / PALETTE	PRICE	PALETTE PRICE
42	KMS 240 bend	OR4S-K90K	KMS 240 bend 90°		240 x 240 x 160 Ø 160 mm	€ 83,60		
42	KMS 240 bend	OR4S-K225K	KMS 240 bend 22,5°		240 x 240 x 123 Ø160 mm	€ 30,50		
42	KMS 240 T-piece	OR4S-T160K	KMS 240 T-piece		240 x 240 x 240 Ø160 mm	€ 81,60		
42	KMS 240 pipe	OR4S-R16-PDK	KMS 240 pipe 160 mm with side clearing lid		240 x 240 x 160 Ø160 mm	€ 78,20		
42	KMS 240 bend 90°	OR4S-K92K	KMS 240 bend 90° with side opening		240 x 240 x 160 Ø160 mm	€ 122,50		
42	KMS 240 bend 90°	OR4S-K93K	KMS 240 bend 90° with top opening		240 x 240 x 160 Ø 160 mm	€ 122,50		
42	KMS 240 cleaning lid	OR4S-PD1K	KMS 240 cleaning lid 1 top		pc. = 1,00	€ 29,80		
42	KMS 240 cleaning lid	OR4S-PD2K	KMS 240 cleaning lid 2 side		pc. = 1,00	€ 29,80		
42	KMS 240 pipe	OR4S-R16-30K	KMS 240 pipe 160 mm with bypass ø 30 mm		240 x 240 x 160 Ø 160 mm	€ 77,50		
42	KMS 240 bypass	OR4S-BP-30K	KMS 240 pipe bypass and bends ø 30 mm		pc. = 1,00	€ 46,00		
43	KMS-240 Bogen 90° mit Bypass	OR4S-K94-30K	mit Bypass oben 24 mm, 240 x 240 x 160 mm Ø 160 mm inkl. BP und Loch 30 mm		240 x 240 x 160 Ø 160 mm	€ 125,10		
43	KMS 240 bend with bypass	OR4S-K95-30K	mit Bypass seitlich 24 mm, 240 x 240 x 160 mm Ø 160 mm inkl. BP und Loch 30 mm		240 x 240 x 160 Ø 160 mm	€ 125,10		

PAGE	ARTICLE	ARTICLE NR.	SPECIFICATION	FEATURE	AMOUNT WEIGHT (KG)	PIECE / PALETTE	PRICE	PALETTE PRICE
43	KMS 240 bend bypass	OR4S-EA16K	KMS 240 Anschluss für Eisen- rohr 240 x 240 x 80, Ø160 mm		240 x 240 x 80 Ø 160 mm		€ 36,30	
43	KMS 240 steel pipe connector	OR4S-R08AK	KMS 240 Rohr Halbtteil mit Anheizklappe 240 x 240 x 80, Ø160 mm		240 x 240 x 80 Ø 160 mm		€ 165,30	
43	KMS 240 pipe	OR4S-RK	KMS 240 Ring zu Rohrsystem		pc. = 0,50		€ 12,20	
43	Universal joint	OR4S-W101	KMS Schaltgriff mit Gelenk- welle		pc. = 0,5		€ 172,60	
43	flexible elbow	OR4S-S25	for filling up empty spaces within accumulation		sack = 25,00		€ 42,60	
43	KMS 240 ring	OR4S-KA240	KMS Adapter stehend 300 - 240 300 x 300 x 100, Ø180 - Ø160 mm		300 x 300 x 100 Ø180- Ø160 mm		€ 115,60	
43	baffle 2 for KMS 240	OR4S-DS2K	Drosselscheibe 2 für KMS 240		pc. = 0,740		€ 28,00	
43	baffle 5 for KMS 240	OR4S-DS5K	Drosselscheibe 5 für KMS 240		pc. = 0,90		€ 29,10	
43	baffle 7 for KMS 240	OR4S-DS7K	Drosselscheibe 7 für KMS 240		pc. = 1,1		€ 30,20	
43	temperature sensor	OR-TE4	Thermoelement lang 4lf m.Keramikschatzh.		pc. = 1,0		€ 106,10	
43	KMS NHK 240	OR4S-NHK240	KMS-240 Reheating box set		pc. = 117,50		€ 711,30	
43	KMS NHK 240 with pre- heat path	OR4S-NHF240	KMS-240 Reheating box set with preheat path		pc. = 178,2		€ 976,00	
43	BIS 240 Verti- cal corner	OR-BIS-EHK	vertical, 240 x 240 x 65 mm		pc. = 2,61		€ 17,60	







PAGE	ARTICLE	ARTICLE NR.	SPECIFICATION	FEATURE	AMOUNT WEIGHT (KG)	PIECE / PALETTE	PRICE	PALETTE PRICE
43	BIS 240 Horizontal corner 22,5°	OR-BIS-225K	horizontal, 240 x 65 mm		pc. = 1,00		€ 12,20	
43	BIS 240 Horizontal corner	OR-BIS-ELK	Corner 90° horizontal, 240 x 240 x 65 mm		pc. = 2,60		€ 17,60	
43	BIS 240 Vertical element 8 cm	OR-BIS-LHK	80 mm, 240 x 80 x 65 mm		pc. = 1,04		€ 10,40	
43	BIS 240 Vertical element 16 cm	OR-BIS-LK	160 mm, 240 x 160 x 65 mm		pc. = 2,00		€ 17,60	
44	Chimney connector square	OR21550	inside 150 x 150 mm – outside 280 x 280 mm		1 pc. = 1,00		€ 39,90	
44	Chimney connector square	OR21880	inside 180 x 180 mm – outside 280 x 280 mm		1 pc. = 1,00		€ 42,60	
44	Chimney connector square	OR21220	inside 200 x 200 mm – outside 330 x 330 mm		1 pc. = 1,00		€ 45,40	
44	Chimney connector rounded 45°	OR21664	RR 160 x 45 x 160		1 pc. = 1,00		€ 61,90	
44	Chimney connector rounded 45°	OR21684	RR 160 x 45 x 180		1 pc. = 1,00		€ 61,90	
44	Chimney connector rounded 45°	OR21884	RR 180 x 45 x 180		1 pc. = 1,00		€ 63,10	
44	Chimney connector rounded 45°	OR21824	RR 180 x 45 x 200		1 pc. = 1,00		€ 63,10	
44	Chimney connector rounded 45°	OR21224	RR 200 x 45 x 200		1 pc. = 1,00		€ 66,10	
44	Chimney connector rounded 45°	OR21254	RR 200 x 45 x 250		1 pc. = 1,00		€ 66,10	















PAGE	ARTICLE	ARTICLE NR.	SPECIFICATION	FEATURE	AMOUNT WEIGHT (KG)	PIECE / PALETTE	PRICE	PALETTE PRICE	
44	Chimney connector rounded 45°	OR21554	RR 250 x 45 x 250		1 pc. = 1,00		€ 71,70		
44	Chimney connector rounded 90°	OR21009	RR 100 x 90 x 100		1 pc. = 1,00		€ 47,30		
44	Chimney connector rounded 90°	OR21119	RR 120 x 90 x 120		1 pc. = 1,00		€ 50,60		
44	Chimney connector rounded 90°	OR21669	RR 160 x 90 x 160		1 pc. = 1,00		€ 58,10		
44	Chimney connector rounded 90°	OR21689	RR 160 x 90 x 180		1 pc. = 1,00		€ 58,10		
44	Chimney connector rounded 90°	OR21889	RR 180 x 90 x 180		1 pc. = 1,00		€ 57,10		
44	Chimney connector rounded 90°	OR21829	RR 180 x 90 x 200		1 pc. = 1,00		€ 57,10		
44	Chimney connector rounded 90°	OR21229	RR 200 x 90 x 200		1 pc. = 1,00		€ 60,70		
44	Chimney connector rounded 90°	OR21259	RR 200 x 90 x 250		1 pc. = 1,00		€ 60,70		
44	Chimney connector rounded 90°	OR21559	RR 250 x 90 x 250		1 pc. = 1,00		€ 67,90		
45	Isoboard 500 mm	OR40230K	750 x 500 x 30 mm		box = 4 pc. / 1,5 m2		€ 61,90		
45	Isoboard 500 mm	OR40230	750 x 500 x 30 mm		palette = 60 pc. / 22,5 m2		€ 822,80		
45	Isoboard 1.000 mm	OR40231	750 x 1.000 x 30 mm		1 pc. = 0,75 m2 palette = 30 pc. / 22,5 m2		€ 30,30	€ 822,80	















PAGE	ARTICLE	ARTICLE NR.	SPECIFICATION	FEATURE	AMOUNT WEIGHT (KG)	PIECE / PALETTE	PRICE	PALETTE PRICE	
45	Isoboard HD 1200	OR40233	610x1000x30	1100°C	1 pc. / palette 60 Stk	€ 71,60	€ 4.160,00		
45	Isoboard glue	OR9903	Fireproof glue up to 1100 °C, paste		bucket = 3 kg	€ 14,70			
45	Isoboard glue	OR9903-1	Fireproof glue up to 1100 °C, thick liquid		plastic bag = 1 kg	€ 6,80			
46	Oven-setter wire	OR92010	in rods		1 set ca. 168 pcs. a 1,2 m = 201,6 m	€ 54,70			
46	Cantilever arm	OR90712	cantilever 400 mm, height 350- 550mm		1 piece	€ 106,80			
46	Cable Flap	OR90120	Cable flap 1600 mm, Ø 0 200 mm	Ø 200 mm	1 piece	€ 83,70			
46	Cable flap, heat resi- stant up to 180°	OR90150	Cable flap 1600 mm, Ø 150 mm	Ø 150 mm	1 piece	€ 149,90			
46	Cable flap, heat resi- stant up to 180°	OR90200	Cable flap 1600 mm, Ø 200 mm	Ø 200 mm	1 piece	€ 153,10			
47	Smoke pipe	H120-250	Ø 120, redu- ced, 250 mm		pc. = 1,25	€ 12,50			
47	Smoke pipe	H120-500	Ø 120, reduced, 500 mm		pc. = 3,40	€ 18,40			
47	Smoke pipe	H120-1000	Ø 120, reduced, 1000 mm		pc. = 7,00	€ 31,60			
47	Smoke pipe	H160-250	Ø 160, reduced, 250 mm		pc. = 1,95	€ 13,50			
47	Smoke pipe	H160-500	Ø 160, reduced, 500 mm		pc. = 3,90	€ 20,40			
47	Smoke pipe	H160-1000	Ø 160, reduced, 1000 mm		pc.= 7,95	€ 33,90			
47	Smoke pipe	H180-250	Ø 180, reduced, 250 mm		pc.= 2,20	€ 14,80			
47	Smoke pipe	H180-500	Ø 180, reduced, 500 mm		pc. = 4,40	€ 21,50			

PAGE	ARTICLE	ARTICLE NR.	SPECIFICATION	FEATURE	AMOUNT WEIGHT (KG)	PIECE / PALETTE	PRICE	PALETTE PRICE
47	Smoke pipe	H180-1000	∅ 180, reduced, 1000 mm		pc. = 9,00		€ 35,90	
47	Smoke pipe	H200-250	∅ 200, reduced, 250 mm		pc. = 2,50		€ 16,10	
47	Smoke pipe	H200-500	∅ 200, reduced, 500 mm		pc. = 5,00		€ 24,10	
47	Smoke pipe	H200-1000	∅ 200, reduced, 1000 mm		pc. = 10,00		€ 38,40	
47	Smoke pipe	H250-250	∅ 250, reduced, 250 mm		pc. = 3,10		€ 19,80	
47	Smoke pipe	H250-500	∅ 250, reduced, 500 mm		pc. = 6,20		€ 29,80	
47	Smoke pipe	H250-1000	∅ 250, reduced, 1000 mm		pc. = 12,50		€ 50,90	
48	Elbow	H120-45	∅ 120, rotatable, reduced, 0- 45°		pc. = 1,70		€ 28,30	
48	Elbow	H120-90	∅ 120, rotatable, reduced, 0-90°		pc. = 1,70		€ 28,30	
48	Elbow	H160-45	∅ 160, rotatable, reduced, 0- 45°		pc. = 1,90		€ 31,60	
48	Elbow	H160-90	∅ 160, rotatable, reduced, 0-90°		pc. = 1,90		€ 31,60	
48	Elbow	H180-45	∅ 180, rotatable, reduced, 0- 45°		pc. = 2,10		€ 33,50	
48	Elbow	H180-90	∅ 180, rotatable, reduced, 0-90°		pc. = 3,30		€ 33,50	
48	Elbow	H200-45	∅ 200, rotatable, reduced, 0- 45°		pc. = 2,40		€ 35,20	
48	Elbow	H200-90	∅ 200, rotatable, reduced, 0-90°		pc. = 3,70		€ 35,20	
48	Elbow	H250-45	∅ 250, rotatable, reduced, 0- 45°		pc. = 3,30		€ 48,30	
48	Elbow	H 250-90	∅ 250, rotatable, reduced, 0-90°		pc. = 5,20		€ 48,30	
48	Multiple bend	H120-B4	∅ 120, 4 elements, 450 mm		pc. = 4,00		€ 46,40	
48	Multiple bend	H160-B4	∅ 160, 4 elements, 450 mm		pc. = 4,10		€ 47,10	
48	Multiple bend	H180-B4	∅ 180, 4 elements, 450 mm		pc. = 5,00		€ 49,50	
48	Multiple bend	H200-B4	∅ 200, 4 elements, 450 mm		pc. = 5,25		€ 50,60	
48	Multiple bend	H250-B4	∅ 250, 4 elements, 450 mm		pc. = 7,30		€ 66,80	
48	Smoke pipe clip	H120-DS	∅ 120		pc. = 1,40		€ 11,10	

PAGE	ARTICLE	ARTICLE NR.	SPECIFICATION	FEATURE	AMOUNT WEIGHT (KG)	PIECE / PALETTE	PRICE	PALETTE PRICE
48	Smoke pipe clip	H160-DS	Ø 160		pc. = 1,70		€ 11,10	
48	Smoke pipe clip	H180-DS	Ø 180		pc. = 2,00		€ 11,80	
48	Smoke pipe clip	H200-DS	Ø 200		pc. = 2,30		€ 12,50	
48	Smoke pipe clip	H250-DS	Ø 250		pc. = 2,60		€ 13,50	
48	Smoke pipes reduction	H180-160RED	from Ø 180 to Ø 160, reduced		pc. = 1,70		€ 48,30	
48	Smoke pipes reduction	H200-180RED	from Ø 200 to Ø 180, reduced		pc. = 1,90		€ 52,00	
48	Smoke pipe T-piece	H120-T	thickness 2mm, reduced, Ø 120		pc. = 3,50		€ 69,20	
48	Smoke pipe T-piece	H160-T	thickness 2mm, reduced, Ø 160		pc. = 4,00		€ 74,30	
48	Smoke pipe T-piece	H180-T	thickness 2mm, reduced, Ø 180		pc. = 4,00		€ 78,10	
48	Smoke pipe T-piece	H200-T	thickness 2mm, reduced, Ø 200		pc. = 4,50		€ 84,10	
48	Smoke pipe T-piece	H250-T	thickness 2mm, reduced, Ø 250		pc. = 4,51		€ 88,40	
49	Flexible aluminum pipe	BE131-100	NW 100 mm		pc. = 0,50		€ 18,10	
49	Flexible aluminum pipe	BE131-125	NW 125 mm		pc. = 0,50		€ 23,00	
49	Flexible aluminum pipe	BE131-180	NW 180 mm		pc. = 0,50		€ 32,20	
49	Flexible aluminum pipe	BE131-200	NW 200 mm		pc. = 0,50		€ 33,90	
49	Flexible aluminum pipe	BE132-180	very durable, 2 layers, NW 180 mm, max. length 3 m		pc. = 0,50		€ 32,90	

PAGE	ARTICLE	ARTICLE NR.	SPECIFICATION	FEATURE	AMOUNT WEIGHT (KG)	PIECE / PALETTE	PRICE	PALETTE PRICE
49	Flexible aluminum pipe	BE132-200	very durable, 2 layers, NW 200 mm, max. length 3 m		pc. = 0,50		€ 36,30	
49	Hose clip	BE400-100	Hose clip ø90-110mm		pc. = 0,10		€ 4,30	
49	Hose clip	BE400-130	Hose clip ø120-140mm		pc. = 0,10		€ 4,90	
49	Hose clip	BE400-180	Hose clip ø170-190		pc. = 0,10		€ 5,50	
49	Hose clip	BE400-200	Hose clip ø190-210mm		pc. = 0,10		€ 5,50	
49	Heat-resistant smoke	HT160-250	ø 160, length 250 mm		pc. = 1,95		€ 88,10	
49	Heat-resistant smoke pipe	HT180-250	ø 180, length 250 mm		pc. = 2,20		€ 99,00	
49	Heat-resistant smoke	HT160-250A	for automatic control, ø 160 mm				€ 188,20	
49	Heat-resistant smoke	HT180-250A	for automatic control, ø 180 mm				€ 197,00	
49	Heat-resistant smoke	HTR180-160	from ø 180 mm to ø 160 mm		pc. = 4,20		€ 220,20	
50	Rotating chimney cap	OR-AUFSATZ1-140	for chimney CNS ø 140 300°C		1 pieces		€ 278,30	
50	Rotating chimney cap	OR-AUFSATZ1-150	for chimney CNS ø 150 300°C		1 pieces		€ 278,30	
50	Rotating chimney cap	OR-AUFSATZ1-160	for chimney CNS ø 160 300°C		1 pieces		€ 278,30	
50	Rotating chimney cap	OR-Aufsatz1-170	for chimney CNS ø 170 300°C		1 pieces		€ 278,30	
50	Rotating chimney cap	OR-Aufsatz1-180	for chimney CNS ø 180 300°C		1 pieces		€ 278,30	
50	Rotating chimney cap	OR-Aufsatz1-200	for chimney CNS ø 200 300°C		1 pieces		€ 278,30	

PAGE	ARTICLE	ARTICLE NR.	SPECIFICATION	FEATURE	AMOUNT WEIGHT (KG)	PIECE / PALETTE	PRICE	PALETTE PRICE
50	Chimney cap	OR-Aufsatz2-160	for chimney CNS or with a mounting frame		1 pieces		€ 300,10	
50	Chimney cap	OR-Aufsatz2-180	for chimney CNS or with a mounting frame		1 pieces		€ 300,10	
50	Chimney cap	OR-Aufsatz2-200	for chimney CNS or with a mounting frame		1 pieces		€ 300,10	
50	Chimney cap	OR-Aufsatz2-250	for chimney CNS or with a mounting frame		1 pieces		€ 300,10	
50	Plaster board*	OR-PT	5 plaster boards (single pieces available on order)		5pieces		€ 110,10	
50	Igniter	OR-AN12	12 strips		12 strips		€ 3,20	
50	Igniter	OR-AN100	100 strips (box)		100 strips (box)		€ 27,00	
50	Cleaning accessories für KAM	OR-BUERSTE	Cleaning brush for KAM		1 pieces		€ 48,80	
50	beak-shaped spout	OR900-6	beak-shaped spout for mixing liquid can		1 pieces		€ 3,30	
51	FRESCO tool set	OR-WZ001000	Consists of: ORTNER bucket; mason's pan; FRESCO-putty knife wide; putty knife narrow; finishing trowel plastic;		1= SET		€ 100,90	
51	Toolbox	OR-Z1	Mobile work station FatMax 55x41x73		1 pieces		€ 195,20	
51	ORTNER bucket	OR-KUE	ORTNER bucket with cover		20 Liter		€ 2,80	
51	Mason's cup	OR-PFANDL	Mason's cup galvanized		1 pieces		€ 8,40	
51	FRESCO-Putty knife wide	OR-WZ001101	stainless 50 mm		1 pieces		€ 4,10	
51	FRESCO-Putty knife narrow	OR-WZ001102	stainless 40 mm		1 pieces		€ 1,40	

PAGE	ARTICLE	ARTICLE NR.	SPECIFICATION	FEATURE	AMOUNT WEIGHT (KG)	PIECE / PALETTE	PRICE	PALETTE PRICE
51	FRESCO Fi- nishing tro- wel plastic	OR-WZ001103	Plastic 280x140 mm		1 pieces		€ 3,70	
51	FRESCO Finishing trowel ser- rated 4x4	OR-WZ001104	stainless 280x140 mm 4mm serrated		1 pieces		€ 8,20	
51	FRESCO- Smoother	OR-WZ001105	200x80 mm		1 pieces		€ 12,60	
51	FRESCO Roller set	OR-WZ001106	2 rollers incl. grip + trough		1 = SET		€ 2,90	
51	FRESCO Structure creating rubber large	OR-WZ001107	Width 150 mm		1 pieces		€ 9,80	
51	FRESCO Structure creating rubber small	OR-WZ001108	Width 100 mm		1 pieces		€ 9,30	
51	FRESCO Structure creating sponge	OR-WZ001109	Natural sponge ca. 140 mm		1 pieces		€ 6,70	
51	FRESCO Sponge	OR-WZ001110	160 x 110 x 50 mm		1 pieces		€ 1,10	
51	FRESCO Block brush oval	OR-WZ001111	Wooden grip 135x55 mm		1 pieces		€ 16,60	
51	Sandpaper K360	OR-WZ001112	Grit = 360		1 pieces		€ 0,40	
51	FRESCO Rubbing board coar- se	OR-WZ001113	280x140		1 pieces		€ 6,80	
51	FRESCO Rubbing board fine	OR-WZ001114	280x140		1 pieces		€ 6,80	
51	FRESCO Rubbing board spe- cial	OR-WZ001115	Styrofoam		1 pieces		€ 3,10	
52	Special drill	ORSB35	3,2 x 90 mm		1 pieces		€ 6,80	
52	Carbide counterbore	OR92020	for ORTNER special drill 3,2 x 90 mm		1 pieces		€ 30,30	

PAGE	ARTICLE	ARTICLE NR.	SPECIFICATION	FEATURE	AMOUNT WEIGHT (KG)	PIECE / PALETTE	PRICE	PALETTE PRICE
52	Schrauben TN55	OR90500	TN 55 mm		1 Karton = 500 Stk.		€ 24,80	
52	Guss- Schamotte - Brecher	BRE-51SET	Schnittlänge 51 cm, Schnitthöhe 77 mm		55 kg		€ 615,00	
52	Nachrüst- satz	BRE-NACH	für Tischhalterung		0,15 kg		€ 19,20	
52	Ersatzräder	BRE-RAD	Ersatzräder für GS Platten- brecher		2 Stück		€ 17,90	



TERMS AND CONDITIONS

- 1. General:** The following terms and conditions are valid, unless expressly agreed in written form with ORTNER, for all the present and future purchases. The divergent terms or oral agreements are valid only when confirmed by ORTNER in writing. No right can be derived from printing or other errors. All the weight, size, color, price, service and similar specification information stated in catalogues, leaflets, newsletters, advertisements, images and price lists are approximations and only binding for ORTNER when they constitute, in writing, purchase conditions of an ordering transaction. The ORTNER terms and conditions are valid also when the buyers name their own divergent terms, which are not expressly discounted by ORTNER. Orders are only binding to ORTNER by confirmation in writing; ORTNER is even in case of the order acceptance allowed to withdraw from the delivery contract in case of serious doubt that the buyer might not fulfill his contractual obligations.
- 2. Packaging:** The packaging is to the discretion of ORTNER with all due diligence. Special requests and special packaging debit the buyer. ORTNER GmbH is due to the license partnership with ARA (Nr. 16711) not obliged to recover the packaging material; ARA guarantees environmentally friendly disposal. Standardized transport equipment (palettes, barred boxes etc.) are excluded. In case those are not returned, ORTNER GmbH debits the charges to the buyer.
- 3. Shipping:** Up from warehouse shipping takes place always at the risk of the buyer. ORTNER is not liable for damaged or lost goods. All shipping regulations are observed. Any insurance require agreement and debits the buyer.
- 4. Retention of title:** Pending full payment the goods remain owned by ORTNER. By processing the goods with other goods owned by the buyer, they do not acquire the ownership of the new product, but rather performed the processing for ORTNER. In case of the processing of the goods by means of other goods owned by the buyer or goods bought under proviso, ORTNER acquires the sole ownership of the processing material. In case the goods are processed by means of other goods bought under proviso, ORTNER acquires co-ownership of the new product in the relation of value of the goods to the value of the ready, new product. In case of the selling of the goods, the buyer transfers all the claims they have against their customers, and commit themselves to provide all the invoices of the goods with a cession note, which clearly states that all the payments, with full discharge of debtor, can be done exclusively to ORTNER. The buyer is obliged to inform ORTNER immediately of all the third party's proceeding for access to goods bought under proviso.
- 5. Terms of delivery:** The stated delivery periods are non-binding and are to be regarded as approximations. Delivery periods start after clarification of all the technical and mercantile delivery conditions. For lack of special agreements, ORTNER is entitled to partial deliveries. Unpredictable obstacles of any kind and cases of force majeure entitle ORTNER to adequately prolong the delivery periods or to withdraw from delivery. Withdrawal from the contract on the part of the buyer is only possible in case the buyer allowed ORTNER a reasonable period of grace without result. Claims for damages due to late, not executed or only partial deliveries are excluded.
- 6. Prices:** All the prices are quoted by ORTNER ex work. Unless otherwise agreed, charged are the prices valid on the delivery day. The statutory value added tax shall be indicated separately.
- 7. Payment:** In case of first purchase the delivery only against advance payment. The whole amount is due within 30 days of invoice date in full, or with 2% discount within 14 days. Until further notice ORTNER grants 2% discount on cash payments for pick up goods. In special cases, ORTNER reserves the right to demand advance payment adequate to the extent of the order. Checks and bills of exchange are accepted only in lieu of payment. Credit notes are only granted under provision of payment and on the payment day. All the coast, fees, interests and charges connected to the redemption and discounting of all the securities debit the buyer. ORTNER is entitled to refuse the acceptance of bills of exchange and checks without giving reasons.
- 8. Delay in payment:** Shall the date on which the payment is due be exceeded, ORTNER is entitled to charge 2% above current account interest rate plus value added tax. Moreover, all legal costs are debited to the buyer.
- 9. Warranty:** Warranty claims are to be made immediately after their discovery, but not later than after 8 days after the reception of the delivery. The buyers' warranty claims are so restricted, that ORTER is entitled to be extricated from the claims, by cancelation the contract or appropriate price reduction by exchange of the defective part against one free of defects within a month. The warranty claim expires at the latest one month after its rejection by ORTNER. All further damage claims, especially compensation for indirect damage, are generally excluded.
- 10. Returns:** The buyer is not entitled to return goods properly delivered by ORTNER. The return is only possible in original packaging after ORTNER's agreements and must be delivered carriage paid. Taking back is subject to a handling charge of 10% of net value, yet not less than 12 EUR. Custom made or used materials cannot be returned.
- 11. Data protection:** The buyer is aware that the whole ORTNER accounting system is carried out with the aid of computer technology. Under consideration of the federal law of 18.10.1978, BGBl. 565 (Data Protection Act), acc. to the §§ 17 and 18 of the Act, the buyer declares their expressed acceptance of storage and processing of the necessary data between ORTENR and its customers, as well as of the transmission of the data, as far as it does not concern either private or family lives of the customers, to the third parties.
- 12. Jurisdiction place of performance:** The court of jurisdiction for all legal disputes arising from the contractual relationship is St. Pölten; Austrian law applies exclusively, also in case of those Terms and Conditions.

INDEX

PAGE	DESCRIPTION
17	3S Cleaning lid
25	Accessories set ø 600
17	Accumulation board
39	Accumulation connector cover
43	Accumulation filler
24	Additional function: self closing and/or
52	Add-on kit
4	Adhesive mortar
6	Adhesive mortar "Creme"
6	Adhesive plaster
38	Ashtray
25	Automatic control LED/APP
50	beak-shaped spout
16	Bearing stone
43	BIS 240
41	BIS 300
28	Black points with full frame
6	Bond and key coat
46	Cable Flap
46	Cantilever arm
52	Carbide counterbore
52	Cast fireclay – crusher
13	Cast fireclay board
38	Chimney cap
44	Chimney connector rounded 45°
50	Cleaning accessories für KAM
38	Connection adapter
38	Doors
11	Elastic putty
48	Elbow
5	refractory concrete 2200
8	Fibreglass silk grid
7	Fine-grained mortar
13	Fireclay elbow 135°
17	Fireclay frame and lid

PAGE	DESCRIPTION
17	Fireclay lid spare part
17	Fireclay linking element
17	Fireclay lintel beam
13	Fireclay pilaster strip
49	Flexible aluminum pipe
43	flexible elbow
6	Free-style structural plaster
51	FRESCO Block brush oval
7	Fresco Design basic kit
51	FRESCO Finishing trowel plastic
51	FRESCO Roller set
51	FRESCO Rubbing board coarse
51	FRESCO Rubbing board fine
51	FRESCO Sponge
51	FRESCO Structure creating rubber large
51	FRESCO Structure creating sponge
51	FRESCO tool set
51	FRESCO-Putty knife narrow
51	FRESCO-Putty knife wide
51	FRESCO-Smoother
8	Glass fiber grid
24	Glass for doors
49	Heat-resistant smoke pipe
5	HK mortar
49	Hose clip
50	Igniter
18	Inner elbow
45	Isoboard
45	Isoboard glue
39	KAM
38	Kitchen stove
42	KMS 240
41	KMS 300
43	KMS NHK 240
43	KMS NHK 240 with preheat path

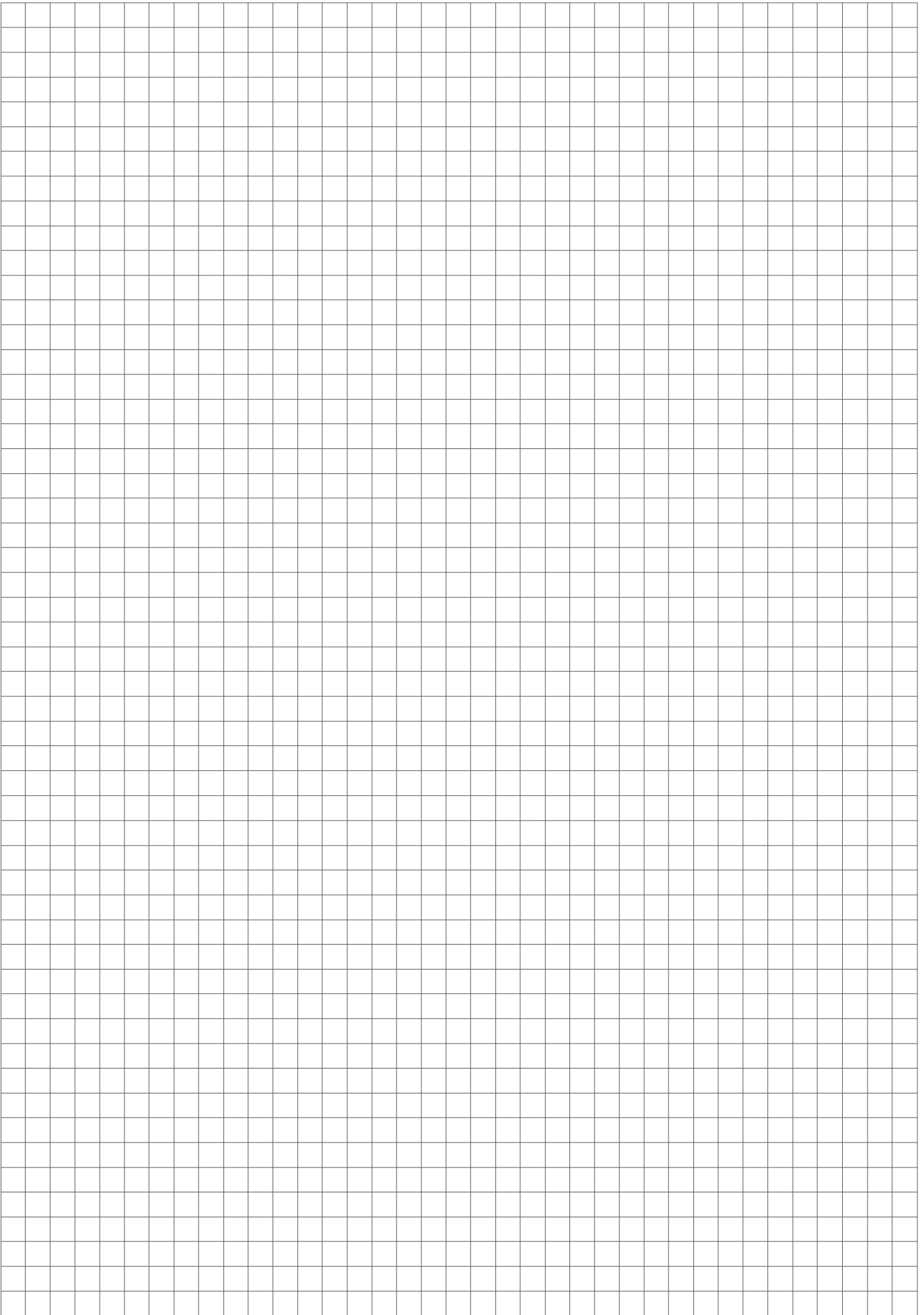

ORTNER
KACHELOFEN MIT SYSTEM

ORTNER GmbH

Hürmer Straße 36
A-3382 Loosdorf/Melk

T +43 (0) 2754 / 2707
F +43 (0) 2754 / 2708
vertrieb@ortner-cc.at

www.ortner-cc.at